



Exploration, Production & Well Service Rubber Products

Catalog EPS 5265

aerospace
climate control
electromechanical
filtration
fluid & gas handling
hydraulics
pneumatics
process control
sealing & shielding



ENGINEERING YOUR SUCCESS.



Failure, improper selection or improper use of the products and/or systems described herein or related items can cause death, personal injury or property damage.

For safe and trouble-free use of these products, it is important that you read and follow the Parker Seal Group Product Safety Guide. This Safety Guide can be referenced and downloaded free of charge at www.parkerseals.com and can be ordered, without charge, as Parker Publication No. PSG 5004 by calling 1-800-C-PARKER.

This document, along with other information from Parker Hannifin Corporation, its subsidiaries and authorized distributors, provides product and/or system options for further investigation by users having technical expertise. It is important that you analyze all aspects of your application and review the information concerning the product or system in the current product catalog. Due to the variety of operating conditions and applications for these products or systems, the user, through his or her own analysis and testing, is solely responsible for making the final selection of the products and systems and assuring that all performance, safety and warning requirements of the application are met. The products described herein, including without limitation, product features, specifications, designs, availability and pricing, are subject to change by Parker Hannifin Corporation and its subsidiaries at any time without notice.

OFFER OF SALE

The items described in this document are hereby offered for sale by Parker Hannifin Corporation, its subsidiaries and its authorized distributors. This offer and its acceptance are governed by the provisions stated on the separate page of this document entitled "Offer of Sale."

© 2013 Parker Hannifin Corporation. All rights reserved.



Table of Contents

• Blowout Preventer Rubbers	2
• Stripper Rubbers	11
• Pipe Wipers	14
• Kelly Wipers	15
• Drill Pipe Protector Rubbers	15
• Packer Rubbers	16
• Water Saver Rubbers	18
• Hammer Union Seals	18
• Diaphragms	19
• Test Cups	20
• Packer Cups	20
• Seal and Repair Kits	21
• Miscellaneous	25
• Swab Cups	26
• Oil Saver Rubbers	27
• Rod Strippers	27

Blowout Preventer Rubbers

Catalog EPS 5265

7-1/16" TYPE U RAM ELEMENT 3M-10M#

PART NO.	PIPE SIZE
PU7-000	Blind (CSO)
PU7-200	2" (2-3/8" OD)
PU7-250	2-1/2" (2-7/8" OD)
PU7-306	3-1/16" OD
PU7-350	3" (3-1/2" OD)
PU7-400	4" OD
PU7-450	4-1/2" OD
PU7-475	4-3/4" OD
PU7-500	5" OD
PU7-550	5-1/2" OD



Note: All sizes of Ram Elements also available in undercuts to accept wear packing, or Snub Pak™, Parker's patented non-rotating BOP Ram Packer and Insert.

7-1/16" TYPE U ACCESSORIES 3M-10M#

PART NO.	PIPE SIZE
PU7-CRSKIT _(3M,5M,10M)	Complete Seal Kit
PU7-CRRKIT _(3M,5M,10M)	Repair Kit
P644909-01	Bonnet Soft Goods Rebuild Kit
PUTS-7	Top Seal
PUBSMN-7	Modified New Style Bonnet Seal
PU-UHMW-7-XXX	UHMW Wear Packing
PU7-(XXX)SPI	Snub Pak Insert for Specified Pipe Size



Note: (XXX) indicates pipe size required.

11" TYPE U RAM ELEMENT 3M-10M#

PART NO.	PIPE SIZE
PU11-000	Blind (CSO)
PU11-100	1" (1.315" OD)
PU11-125	1-1/4" (1.660" OD)
PU11-150	1-1/2" (1.900" OD)
PU11-175	1-3/4" (2-1/16" OD)
PU11-200	2" (2-3/8" OD)
PU11-250	2-1/2" (2-7/8" OD)
PU11-350	3" (3-1/2" OD)
PU11-400	4" OD
PU11-450	4-1/2" OD
PU11-500	5" OD
PU11-550	5-1/2" OD



Note: All sizes of Ram Elements also available in undercuts to accept wear packing, or Snub Pak™, Parker's patented non-rotating BOP Ram Packer and Insert.

7-1/16" TYPE U ACCESSORIES 3M-10M#

PART NO.	PIPE SIZE
PUSR-11	Right Side End Packer
PUSL-11	Left Side End Packer
PUSB-11	Blade Packer

Blowout Preventer Rubbers

Catalog EPS 5265

11" TYPE U ACCESSORIES 3M-10M#

PART NO.	DESCRIPTION
PU11-CRSKIT _(3M,5M,10M)	Complete Seal Kit
PU11-CRRKIT _(3M,5M,10M)	Repair Kit
P644909-02	Bonnet Soft Goods Rebuild Kit
PUTS-11	Top Seal
PUBSMN-11	Modified New Style Bonnet Seal
PU-UHMW-11-XXX	UHMW Wear Packing
PU11-(XXX)SPI	Snub Pak Insert for Specified Pipe Size

Note: (XXX) indicates pipe size required.



13-5/8" TYPE U SHEAR RAM 3M-10M#

PART NO.	PIPE SIZE
PU13-000	Blind (CSO)
PU13-100	1" (1.315" OD)
PU13-125	1-1/4" (1.660" OD)
PU13-150	1-1/2" (1.900" OD)
PU13-175	1-3/4" (2-1/16" OD)
PU13-200	2" (2-3/8" OD)
PU13-250	2-1/2" (2-7/8" OD)
PU13-350	3" (3-1/2" OD)
PU13-400	4" OD
PU13-450	4-1/2" OD
PU13-500	5" OD
PU13-550	5-1/2" OD
PU13-658	6-5/8" OD
PU13-700	7" OD
PU13-758	7-5/8" OD
PU13-800	8" OD
PU13-858	8-5/8" OD
PU13-958	9-5/8" OD



13-5/8" TYPE U SHEAR RAM 3M-10M#

PART NO.	PIPE SIZE
PUSR-13	Right Side End Packer
PUSL-13	Left Side End Packer
PUSB-13	Blade Packer

13-5/8" TYPE U ACCESSORIES RAM 3M-10M#

PART NO.	DESCRIPTION
PU13-CRSKIT _(3M,5M,10M)	Complete Seal Kit
PU13-CRRKIT _(3M,5M,10M)	Repair Kit
P644909-03	Bonnet Soft Goods Rebuild Kit
PUTS-13	Top Seal
PUBSMN-13	Modified New Style Bonnet Seal
PU-UHMW-13-XXX	UHMW Wear Packing

Note: (XXX) indicates pipe size required.

Blowout Preventer Rubbers

Catalog EPS 5265

6" TYPE QRC RAM ELEMENT 3M-5M#

PART NO.	PIPE SIZE
PQ6-000	Blind (CSO)
PQ6-200	2" (2-3/8" OD)
PQ6-250	2-1/2" (2-7/8" OD)
PQ6-350	3" (3-1/2" OD)
PQRS-6	Rear Seal
PQBS-6	Bonnet Seal

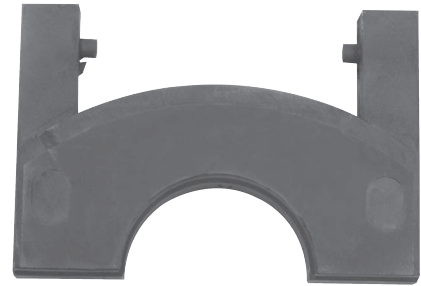

6" LWP TYPE 64 RAM ELEMENT 3M#

PART NO.	PIPE SIZE
P646-000	Blind (CSO)
P646-200	2" (2-3/8" OD)
P646-250	2-1/2" (2-7/8" OD)
P646-350	3" (3-1/2" OD)



6" TYPE 39 RAM ELEMENT 3M-5M#

PART NO.	PIPE SIZE
P396-000	Blind (CSO)
P396-200	2" (2-3/8" OD)
P396-250	2-1/2" (2-7/8" OD)
P396-350	3" (3-1/2" OD)



6" LWS TYPE 61 RAM ELEMENT 3M-5M#

PART NO.	PIPE SIZE
P616-000	Blind (CSO)
P616-200	2" (2-3/8" OD)
P616-250	2-1/2" (2-7/8" OD)
P616-350	3" (3-1/2" OD)



11" LWS TYPE 70 RAM ELEMENT 3M-5M#

PART NO.	PIPE SIZE
P7011-3-000	Blind (CSO)
P7011-3-200	2" (2-3/8" OD)
P7011-3-250	2-1/2" (2-7/8" OD)
P7011-3-350	3" (3-1/2" OD)
P7011-3-400	4" OD
P7011-3-450	4-1/2" OD
P7011-3-500	5" OD
P7011-3-550	5-1/2" OD
P7011-3-658	6-5/8" OD
P7011-3-700	7" OD
P7011-3-758	7-5/8" OD
P70DG-11-3	Door Gasket



Note: All sizes of Ram Elements also available in undercuts to accept wear packing.

Blowout Preventer Rubbers

Catalog EPS 5265

11" LWS TYPE 70 RAM ELEMENT 5M#

PART NO.	PIPE SIZE
P7011-5-000	Blind (CSO)
P7011-5-200	2" (2-3/8" OD)
P7011-5-250	2-1/2" (2-7/8" OD)
P7011-5-350	3" (3-1/2" OD)
P7011-5-400	4" OD
P7011-5-450	4-1/2" OD
P7011-5-500	5" OD
P7011-5-550	5-1/2" OD
P7011-5-658	6-5/8" OD
P7011-5-700	7" OD
P7011-5-758	7-5/8" OD
P70DG-11-5	Door Gasket



11" SL TYPE 75 RAM ELEMENT 10M#

PART NO.	PIPE SIZE
P7511-10-000	Blind (CSO)
P7511-10-200	2" (2-3/8" OD)
P7511-10-250	2-1/2" (2-7/8" OD)
P7511-10-350	3" (3-1/2" OD)
P7511-10-400	4" OD
P7511-10-450	4-1/2" OD
P7511-10-500	5" OD
P7511-10-550	5-1/2" OD
P7511-10-658	6-5/8" OD
P75DG-11-10	Door Gasket



13-5/8" SL TYPE 70 RAM ELEMENT 3M-5M#

PART NO.	PIPE SIZE
P7013-35-000	Blind (CSO)
P7013-35-200	2" (2-3/8" OD)
P7013-35-250	2-1/2" (2-7/8" OD)
P7013-35-350	3" (3-1/2" OD)
P7013-35-400	4" OD
P7013-35-450	4-1/2" OD
P7013-35-500	5" OD
P7013-35-550	5-1/2" OD
P7013-35-658	6-5/8" OD
P7013-35-700	7" OD
P7013-35-758	7-5/8" OD
P70DG-13-35	Door Gasket (#134014)
P70DGM-13-35	Door Gasket (#130203)



Note: All sizes of Ram Elements also available in undercuts to accept wear packing.

Blowout Preventer Rubbers

Catalog EPS 5265

13-5/8" SL TYPE 75 RAM ELEMENT 10M#

PART NO.	PIPE SIZE
P7513-10-000	Blind (CSO)
P7513-10-200	2" (2-3/8" OD)
P7513-10-250	2-1/2" (2-7/8" OD)
P7513-10-350	3" (3-1/2" OD)
P7513-10-400	4" OD
P7513-10-450	4-1/2" OD
P7513-10-500	5" OD
P7513-10-550	5-1/2" OD
P7513-10-658	6-5/8" OD
P7513-10-700	7" OD
P75DG-13-10	Door Gasket



SPHERICAL PACKING ELEMENT

PART NO.	PIPE SIZE
PSS-7-35	7-1/16" 3M-5M#
PSS-11-3	11" 3M#
PSS-11-5	11" 5M#
PSS-13-35	13-5/8" 3M-5M#
PSS-21-2	21-1/4" 2M#



6" A & B RAM ELEMENT

PART NO.	PIPE SIZE
PG6-000	Blind (CSO)
PG6-100	1" (1.315" OD)
PG6-200	2" (2-3/8" OD)
PG6-250	2-1/2" (2-7/8" OD)
PG6-350	3" (3- 1/2" OD)
PG6-400	4" OD
PG6-450	4-1/2" OD
PG6-500	5" OD
PG6-550	5-1/2" OD



6" WSI RAM ELEMENT

PART NO.	PIPE SIZE
PWD6-000	Blind (CSO)
PWD6-200	2" (2-3/8" OD)
PWD6-250	2-1/2" (2-7/8" OD)
PWD6-350	3" (3-1/2" OD)
PWDTS-6	Top Seal
PWDTS-6R	Top Seal Raised
PWDG-6	Door Gasket



Note: All sizes of Ram Elements also available in undercuts to accept wear packing.

Blowout Preventer Rubbers

Catalog EPS 5265

8" RAM ELEMENT

PART NO.	DESCRIPTION
PT8-000	8" BOP Blind
PT8-200	8" BOP Ram 2-3/8"
PT8-250	8" BOP Ram 2-7/8"
PTTS-8	8" Top Seal

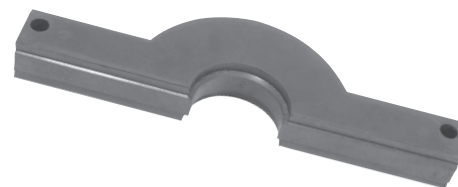

11" TYPE V RAM ELEMENT 3M-5M#

PART NO.	PIPE SIZE
PV11-000	Blind (CSO)
PV11-200	2" (2-3/8" OD)
PV11-250	2-1/2" (2-7/8" OD)
PV11-350	3" (3-1/2" OD)
PV11-450	4-1/2" OD
PV11-500	5" OD
PV11-550	5-1/2" OD
PV11-700	7" OD
PV11-758	7-5/8" OD
PVTS-11	Top Seal
PVBS-11	Bonnet Seal

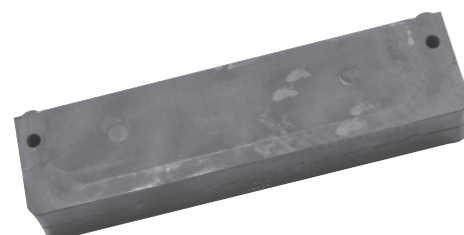

13-5/8" TYPE V RAM ELEMENT 3M-5M#

PART NO.	PIPE SIZE
PV13-000	Blind (CSO)
PV13-200	2" (2-3/8" OD)
PV13-250	2-1/2" (2-7/8" OD)
PV13-350	3" (3-1/2" OD)
PV13-450	4-1/2" OD
PV13-500	5" OD
PV13-550	5-1/2" OD
PV13-700	7" OD
PV13-758	7-5/8" OD
PV13-958	9-5/8" OD
PVTS-11	Top Seal
PVBS-11	Bonnet Seal



Note: All sizes of Ram Elements also available in undercuts to accept wear packing.

Blowout Preventer Rubbers

Catalog EPS 5265

13-5/8" TYPE X RAM ELEMENT 10M#

PART NO.	PIPE SIZE
PX13-000	Blind (CSO)
PX13-200	2" (2-3/8" OD)
PX13-250	2-1/2" (2-7/8" OD)
PX13-350	3" (3-1/2" OD)
PX13-450	4-1/2" OD
PX13-500	5" OD
PX13-550	5-1/2" OD
PX13-700	7" OD
PX13-758	7-5/8" OD
PX13-958	9-5/8" OD
PXTS-13	Top Seal
PXBS-13	Bonnet Seal



GK AND MSP ANNULAR PACKING ELEMENT

PART NO.	DESCRIPTION
PGK-7-3	7-1/16" 3M#
PGK-7-5	7-1/16" 5M#
PGK-11-3	11" 3M#
PGK-11-5	11" 5M#
PGK-13-3	13-5/8" 3M#
PGK-13-5	13-5/8" 5M#
PMSP-21-2	21-1/4" 2M#



2-1/2" NEW STYLE WIRELINE RAM ELEMENT

PART NO.	PIPE SIZE
PB2N-FL	Flat Line
PB2N-316-WL	3/16"
PB2N-732-WL	7/32"
PB2N-516-WL	5/16"
PB2N-716-WL	7/16"
PB2N-153-WL	15/32"

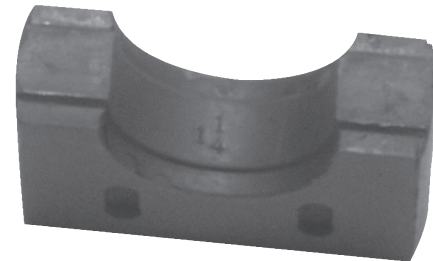

2-1/2" NEW STYLE RAM ELEMENT

PART NO.	PIPE SIZE
PB2N-000	Blind (CSO)
PB2N-075	3/4" OD
PB2N-100	1" (1.315" OD)
PB2N-125	1-1/4" (1.660" OD)

2-1/2" NEW STYLE COIL TUBING RAM ELEMENT

PART NO.	PIPE SIZE
PB2N-100-CT	1" OD
PB2N-100	1-1/4" OD
PB2N-125	1-1/2" OD

Note: All sizes of Ram Elements also available in undercuts to accept wear packing.

Blowout Preventer Rubbers

Catalog EPS 5265

2-1/2" NEW STYLE ACCESSORIES

PART NO.	DESCRIPTION
PBO-2	2-1/2" Outer Seal



2-1/2" OLD STYLE RAM ELEMENT 10M#

PART NO.	PIPE SIZE
PB30-000	Blind (CSO)
PB30-075	3/4" OD
PB30-100	1" (1.315" OD)
PB30-125	1-1/4" (1.660" OD)
PB30-150	1-1/2" (1.900" OD)
PB30-175	1-3/4" (2-1/16" OD)

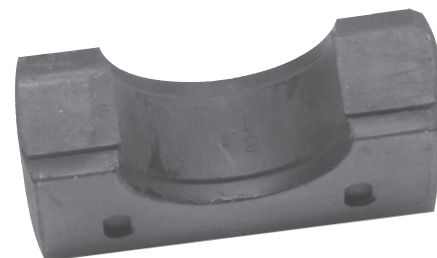

2-1/2" NEW STYLE WIRELINE RAM ELEMENT

PART NO.	PIPE SIZE
PB30-FL	Flat Line
PB30-316-WL	3/16"
PB30-732-WL	7/32"
PB30-516-WL	5/16"
PB30-716-WL	7/16"
PB30-153-WL	15/32"

3-1/16" NEW STYLE RAM ELEMENT 15M#

PART NO.	PIPE SIZE
PB3N-000	Blind (CSO)
PB3N-075	3/4" OD
PB3N-100	1" (1.315" OD)
PB3N-125	1-1/4" (1.660" OD)
PB3N-150	1-1/2" (1.900" OD)
PB3N-175	1-3/4" (2-1/16" OD)

4-1/16" OLD STYLE RAM ELEMENT 10M#

PART NO.	PIPE SIZE
PB40-000	Blind (CSO)
PB40-075	3/4" OD
PB40-100	1" (1.315" OD)
PB40-125	1-1/4" (1.660" OD)
PB40-150	1-1/2" (1.900" OD)
PB40-175	1-3/4" (2-1/16" OD)
PB40-200	2" (2-3/8" OD)
PB40-250	2-1/2" (2-7/8" OD)

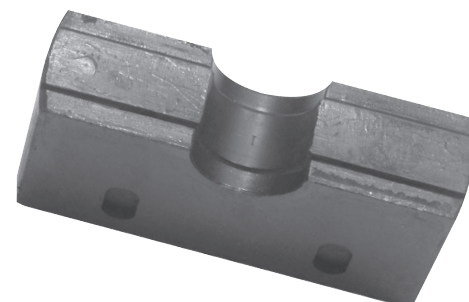

Note: All sizes of Ram Elements also available in undercuts to accept wear packing.

Blowout Preventer Rubbers

Catalog EPS 5265

4-1/16" NEW STYLE RAM ELEMENT 15M#

PART NO.	PIPE SIZE
PB4N-000	Blind (CSO)
PB4N-075	3/4" OD
PB4N-100	1" (1.315" OD)
PB4N-125	1-1/4" (1.660" OD)
PB4N-150	1-1/2" (1.900" OD)
PB4N-175	1-3/4" (2-1/16" OD)
PB4N-200	2" (2-3/8" OD)
PB4N-250	2-1/2" (2-7/8" OD)

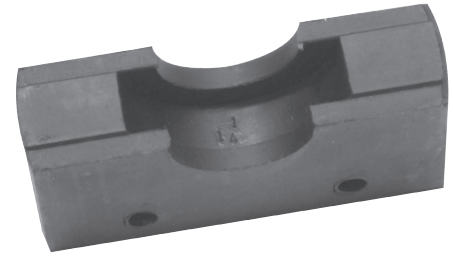

4-1/16" ACCESSORIES

PART NO.	DESCRIPTION
PBO-4	4-1/16" Outer Seal
PBB-4	4-1/16" Outer Seal
PB4-UHMW-XXX	UHMW Stripper Inserts



Note: (XXX) indicates pipe size required.

Note: All sizes of Ram Elements also available in undercuts to accept wear packing.

Stripper Rubbers

Catalog EPS 5265

STRIPPER RUBBER (SHORT HALL)

PART NO.	SIZE
RXH-100	1" (1.315" OD)
RXH-120	1-1/4" (1.660" OD)
RXH-150	1-1/2" (1.900" OD)
RXH-175	1-3/4" (2-1/16" OD)
RXH-200	2" (2-3/8" OD)
RXH-250	2-1/2" (2-7/8" OD)
RXH-300	3" (3-1/2" OD)



TYPE 2 (PX-107) STRIPPER RUBBER

PART NO.	SIZE
BIW-2-20	2" (2-3/8" OD)
BIW-2-25	2-1/2" (2-7/8" OD)



TYPE 1 (PX-70) STRIPPER RUBBER

PART NO.	SIZE
BIW-1-20	2" (2-3/8" OD)
BIW-1-25	2-1/2" (2-7/8" OD)
BIW-1-30	3" (3-1/2" OD)



STRIPPER RUBBER

PART NO.	SIZE
R20155-3	2" (2-3/8" OD)
R20155-2	2-1/2" (2-7/8" OD)



SR STRIPPER RUBBER

PART NO.	SIZE
LSR-20	2" (2-3/8" OD)
LSR-25	2-1/2" (2-7/8" OD)



K STRIPPER RUBBER

PART NO.	SIZE
LSK-20	2" (2-3/8" OD)
LSK-25	2-1/2" (2-7/8" OD)



Stripper Rubbers

Catalog EPS 5265

JU STRIPPER RUBBER

PART NO.	SIZE
R-10	1" (1.315" OD)
R-12	1-1/4" (1.660" OD)
R-15	1-1/2" (1.900" OD)
R-216	1-3/4" (21/16" OD)
R-20	2" (2-3/8" OD)
R-25	2-1/2" (2-7/8" OD)
R-30	3" (3-1/2" OD)



STRIPPER RUBBER

PART NO.	SIZE
RHS-200	2" (2-3/8" OD)
RHS-250	2-1/2" (2-7/8" OD)



TYPE SS STRIPPER RUBBER

PART NO.	SIZE
REC-20	2" (2-3/8" OD)
REC-25	2-1/2" (2-7/8" OD)
REC-30	3" (3-1/2" OD)



S-6 STRIPPER RUBBER

PART NO.	SIZE
R-GSR-20	2"
R-GSR-25	2-1/2"



STRIPPER RUBBER JI AND JF

PART NO.	SIZE
ROS-12	1-1/4"
ROS-15	1-1/2"
ROS-20	2"
ROS-25	2-1/2"
ROS-30	3"



Stripper Rubbers

Catalog EPS 5265

ROTATING HEAD STRIPPER RUBBER

PART NO.	PIPE SIZE
PGSR-200	2-3/8" OD
PGSR-250	2-7/8" OD
PGSR-350	3-1/2" OD
PGSR-450	4-1/2" OD

3-1/2" COIL TUBING INTERLOCKING STRIPPER RUBBER

PART NO.	PIPE SIZE
R-TLSR-3100U	1.000 OD
R-TLSR-3125U	1.250 OD
R-TLSR-3150U	1.500 OD

4" COIL TUBING INTERLOCKING STRIPPER RUBBER

PART NO.	PIPE SIZE
R-TLSR-4100U	1.000 OD
R-TLSR-4125U	1.250 OD
R-TLSR-4150U	1.500 OD
R-TLSR-4175U	1.750 OD
R-TLSR-4200U	2.000 OD

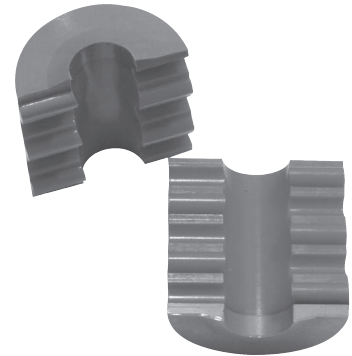

7-1/16" SNUBBING STRIPPER RUBBER

PART NO.	PIPE SIZE
P7USR-200	2" (2-3/8" OD)
P7USR-250	2-1/2" (2-7/8" OD)
P7USR-350	3" (2-1/2" OD)



Pipe Wipers

Catalog EPS 5265

COIL TUBING SPLIT PIPE WIPER

PART NO.	PIPE SIZE
PBSPW-100	1"
PBSPW-125	1-1/4"
PBSPW-150	1-1/2"

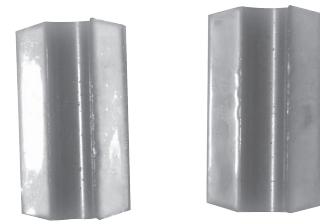

ENERGIZER SPRING

PART NO.	DESCRIPTION
PBES-4	For Coil Tubing Split Pipe Wiper



9" FLAT PIPE WIPER

PART NO.	PIPE SIZE
RFW-910	1" (1.315" OD)
RFW-920	2" (2-3/8" OD)
RFW-925	2-1/2" (2-7/8" OD)

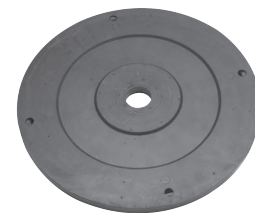

17" FLAT PIPE WIPER

PART NO.	PIPE SIZE
RFW-1720	2" (2-3/8" OD)
RFW-1725	2-1/2" (2-7/8" OD)
RFW-1735	3" (3-1/2" OD)

Note: All pipe wipers flat.

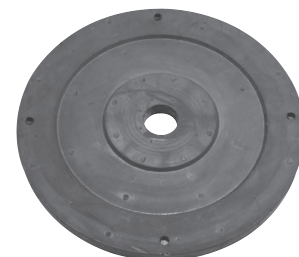

17" DUAL PIPE WIPER

PART NO.	PIPE SIZE
RDS-1720	2" (2-3/8" OD)
RDS-1725	2-1/2" (2-7/8" OD)
RDS-1735	3" (3-1/2" OD)

Note: All dual split wipers.



19" FLAT PIPE WIPER

PART NO.	PIPE SIZE
RFW-1920	2" (2-3/8" OD)
RFW-1925	2-1/2" (2-7/8" OD)
RFW-1935	3" (3-1/2" OD)

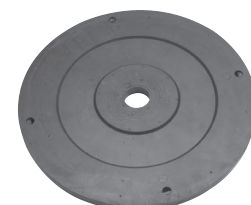

Pipe Wipers

Catalog EPS 5265

19" DUAL PIPE WIPER

PART NO.	PIPE SIZE
RDS-1920	2" (2-3/8" OD)
RDS-1925	2-1/2" (2-7/8" OD)
RDS-1935	3" (3-1/2" OD)



22" FLAT PIPE WIPER

PART NO.	PIPE SIZE
RFW-2220	2" (2-3/8" OD)
RFW-2225	2-1/2" (2-7/8" OD)

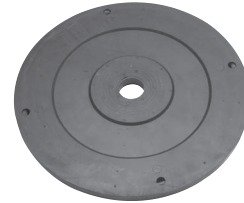

Kelly Wipers

TYPE "SQUARE"

PART NO.	OD DIAMETER	SIZE ACROSS FLAT
RKW-10350S		3-1/2"
RKW-10425S		4-1/4"
RKW-10525S		5-1/4"

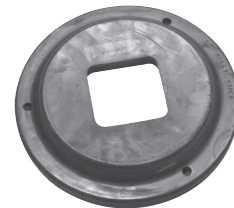

TYPE "HEXAGONAL"

PART NO.	OD DIAMETER	SIZE ACROSS FLAT
RKW-10350H		3-1/2"
RKW-10425H		4-1/4"
RKW-10525H		5-1/4"

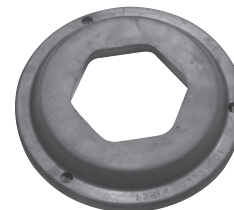

Drill Pipe Protector Rubbers

SPIRAL FLUTED DRILL PIPE PROTECTOR

PART NO.	PIPE SIZE
PSFDP-3552	3-1/2" X 5-1/4"
PSFDP-4572	4-1/2" X 7-1/4"
PSFDP-5072	5" X 7-1/4"

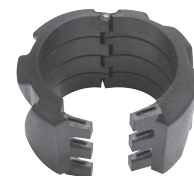

STRAIGHT FLUTED DRILL PIPE PROTECTOR

PART NO.	PIPE SIZE
PFDP-4057	4" X 5-3/4"
PFDP-5075	5" X 7-1/2"
PFDP-6690	6-5/8" X 9"

DRILL PIPE PROTECTOR ACCESSORIES

PART NO.	DESCRIPTION
PDPLP	Latch Pin
PDPPIT	Installation Tool

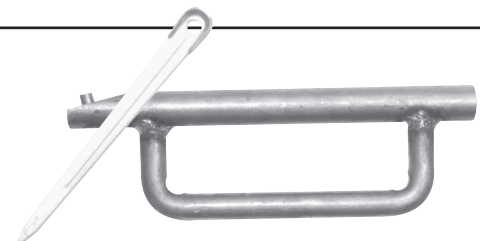

Packer Rubbers

Catalog EPS 5265

BAR PACKER

PART NO.	ID	OD	DESCRIPTION
BP-15075150	.750" ID	1.500" OD	2.90# 1-1/2"
BP-15087150	.875" ID	1.500" OD	2.90# 1-1/2"
BP-15089150	.890" ID	1.500" OD	2.90# 1-1/2"
BP-17112165	1.125" ID	1.650" OD	3.25# 2-1/16"
BP-20112189	1.125" ID	1.890" OD	4.70# 2-3/8"
BP-20125189	1.250" ID	1.890" OD	4.70# 2-3/8"
BP-20126189	1.266" ID	1.890" OD	4.70# 2-3/8"
BP-20112182	1.125" ID	1.825" OD	5.30# 2-3/8"
BP-20125182	1.250" ID	1.825" OD	5.30# 2-3/8"
BP-20126182	1.266" ID	1.825" OD	5.30# 2-3/8"
BP-20112179	1.125" ID	1.790" OD	5.95# 2-3/8"
BP-20125179	1.250" ID	1.790" OD	5.95# 2-3/8"
BP-20126179	1.266" ID	1.790" OD	5.95# 2-3/8"
BP-25123234	1.235" ID	2.340" OD	6.50# 2-7/8"
BP-25125234	1.250" ID	2.340" OD	6.50# 2-7/8"
BP-25126234	1.266" ID	2.340" OD	6.50# 2-7/8"
BP-25132234	1.325" ID	2.340" OD	6.50# 2-7/8"
BP-25150234	1.500" ID	2.340" OD	6.50# 2-7/8"
BP-25160234	1.600" ID	2.340" OD	6.50# 2-7/8"
BP-25176234	1.765" ID	2.340" OD	6.50# 2-7/8"
BP-25123216	1.235" ID	2.160" OD	8.70# 2-7/8"
BP-25125216	1.250" ID	2.160" OD	8.70# 2-7/8"
BP-25126216	1.266" ID	2.160" OD	8.70# 2-7/8"
BP-25132216	1.325" ID	2.160" OD	8.70# 2-7/8"
BP-25150216	1.500" ID	2.160" OD	8.70# 2-7/8"
BP-25160216	1.600" ID	2.160" OD	8.70# 2-7/8"



Note: All Bar Packer parts are available in 70, 80, and 90 durometer rubber.
Please specify when placing an order. Call for availability of other size combinations.

Packer Rubbers

Catalog EPS 5265

BAR PACKER

PART NO.	ID	OD	DESCRIPTION
BP-25123225	1.235" ID	2.250" OD	7.90# 2-7/8"
BP-25125225	1.250" ID	2.250" OD	7.90# 2-7/8"
BP-25126225	1.266" ID	2.250" OD	7.90# 2-7/8"
BP-25132225	1.325" ID	2.250" OD	7.90# 2-7/8"
BP-25150225	1.500" ID	2.250" OD	7.90# 2-7/8"
BP-25160225	1.600" ID	2.250" OD	7.90# 2-7/8"
BP-35150288	1.500" ID	2.880" OD	9.30# 3-1/2"
BP-35160288	1.600" ID	2.880" OD	9.30# 3-1/2"
BP-35176288	1.765" ID	2.880" OD	9.30# 3-1/2"
BP-35197288	1.975" ID	2.880" OD	9.30# 3-1/2"
BP-35150277	1.500" ID	2.775" OD	10.30# 3-1/2"
BP-35160277	1.600" ID	2.775" OD	10.30# 3-1/2"
BP-35176277	1.765" ID	2.775" OD	10.30# 3-1/2"
BP-35197277	1.975" ID	2.775" OD	10.30# 3-1/2"
BP-35150262	1.500" ID	2.620" OD	12.95# 3-1/2"
BP-35160262	1.600" ID	2.620" OD	12.95# 3-1/2"
BP-35176262	1.765" ID	2.620" OD	12.95# 3-1/2"
BP-35197262	1.975" ID	2.620" OD	12.95# 3-1/2"



Note: All Bar Packer parts are available in 70, 80, and 90 durometer rubber. Please specify when placing an order. Call for availability of other size combinations.

Note: All sizes of Ram Elements also available in undercuts to accept wear packing.

Water Saver Rubbers

Catalog EPS 5265

WATER SAVER

PART NO.	SIZE
PWS-175	2-1/16"
PWS-200	2-3/8"
PWS-250	2-7/8"
PWS-350	3-1/2"
PWS-450	4-1/2"



Hammer Union Seals

S.O.M. HAMMER UNION SEALS

PART NO.	SIZE
PGHUS-100	1"
PGHUS-150	1-1/2"
PGHUS-200	2"
PGHUS-300	3"

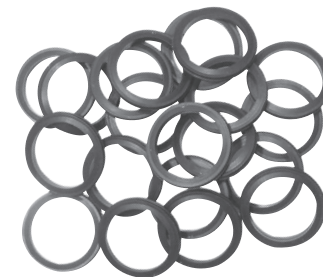

WECO OR BEST HAMMER UNION SEALS

PART NO.	SIZE
PWHUS-100	1"
PWHUS-150	1-1/2"
PWHUS-200	2"
PWHUS-300	3"
PWHUS-400	4"



Note: All sizes of Ram Elements also available in undercuts to accept wear packing.

Diaphragms

Catalog EPS 5265

CE DIAPHRAGMS

PART NO.	SIZE
PCED-18	18"
PCE-24	24"



PULSATION DAMPENER BLADDER

PART NO.	SIZE
PPD55	20 Gallon



CATHEAD DIAPHRAGM

PART NO.	SIZE
PNCD-18	18"



K-10 PULSATION DAMPENER

PART NO.	DESCRIPTION
PPDB-K10	10 Gallon Bladder
PPDBS-K10	Stabilizer
PB-K10	K-10 Bolt
PW-K10	K-10 Washer
PP-K10	K-10 Plate
PPG-K10	Pressure Gauge
PCV-K10	Charging Valve
PBPG-K10	Bottom Plate Gasket
PPDBSET-K10	K-10 Repair Kit

K-20 PULSATION DAMPENER

PART NO.	DESCRIPTION
PPDB-K20	20 Gallon Bladder
PPDBS-K20	Stabilizer
PB-K20	K-20 Bolt
PW-K20	K-20 Washer
PP-K20	K-20 Plate
PPG-K20	Pressure Gauge
PCV-K20	Charging Valve
PBPG-K20	Bottom Plate Gasket
PPDBSET-K20	K-20 Repair Kit



Test Cups

Catalog EPS 5265

TYPE F TEST CUP

PART NO.	PIPE SIZE
PCFTC-30593	5-1/2" (All #)
PCFTC-30597	6-5/8" (All #)
PCFTC-30598-01	7" (29-38#)
PCFTC-30598-02	7" (17-28#)
PCFTC-30599-01	7-5/8" (24-26.4#)
PCFTC-30599-02	7-5/8" (29.7-39#)
PCFTC-30606-02	8-5/8" (34-36#)
PCFTC-30601-01	9-5/8" (32.3-40#)
PCFTC-30601-02	9-5/8" (43.5-53.5#)
PCFTC-30607-01	10-3/4" (32.75-51#)
PCFTC-30607-02	10-3/4" (55.5-65.7#)
PCFTC-30579-01	13-3/8" (68-72#)
PCFTC-30579-02	13-3/8" (48-61#)
PCFTC-30584	16 (All#)
PCFTC-674819	18-5/8" (All#)
PCFTC-33543	20" (78.6-129.3#)



TYPE F TEST CUP MANDREL AND SUB

PART NO.	DESCRIPTION
PCFM-200	2-3/8" IF
PCFM-350	3-1/2" IF
PCFM-450	4-1/2" IF



Packer Cups

TYPE GW CUPS

PART NO.	DESCRIPTION
PGWC-7.000	7", 17-20#
PGWC-7.000HD	7", 22-24#, Heavy Duty
PGWC-9.625-4.5	9-5/8", 36-43.5#
PGWC-10.750-4.5	10-3/4", 32.8-55.5#



Seal and Repair Kits

Catalog EPS 5265

7-1/16" TYPE U SEAL KIT

STYLE	PART NO.	DESCRIPTION	QTY.	NOTES
#1 Old	19060-1	Bonnet Seal	2	
#1 New	46613-1	Bonnet Seal	2	
#1 Cam Ram	644197-1	Bonnet Seal	2	
#2 Old	12469-36	Ring, Plastic Packing	2	
#3 Old	18586-12	Ring, Plastic Energizing	2	
#4 Old	18492-92	O-ring, Operate Piston Rod to Int. Flange	2	
#5 Old	18492-84	O-ring, Operate Piston	2	
#5 New	704774	Lip Seal, Operate Piston	2	
#6 Old	11741-32	Seal Ring, Tail Rod	2	
#7 Old	11741-37	Ring, Connecting Rod	2	
#8 Old	18491-73	O-ring, Ram Change Piston to Body	4	
#9 Old	6227-73-13-85	O-ring, Operating Cylinder	4	
#10 Old	6227-34-01-70	O-ring, Wiping	2	
#11 Old	6227-32-13-85	O-ring, Ram Change Piston to Int. Flange	4	
#12 Old	6227-41-13-85	O-ring, Ram Change Cylinder to Int. Flange	4	
#13 Old	6227-45-13-85	O-ring, Ram Change Cylinder to Bonnet	4	
#14 Old	6227-35-13-85	O-ring, Ram Change Piston	4	
#15 Old	6230-01-13-85	O-ring, Bonnet Bolt Retainer	8	

TO MAKE 7-1/16" SEAL KIT INTO REPAIR KIT INCLUDE #16 THRU #19:

STYLE	PART NO.	DESCRIPTION	QTY.	NOTES
#16	21792-21	Back-up Ring	4	
#17	49223-03	Wear Band	2	
#18	2353-26	Washer	2	
#19	18572-83	Retainer Ring	2	
ITEMS #1-15		Complete Old Style Seal Kit (OS Bonnet)		
ITEMS #1-15		Complete Cam Ram Seal Kit (C/R Bonnet & NS Piston)		
ITEMS #1-19		Complete Old Style Repair Kit		
ITEMS #1-15		Complete Cam Ram Repair Kit		

Note: Individual parts can be quoted on request.

Seal and Repair Kits

Catalog EPS 5265

11" TYPE U SEAL KIT

STYLE	PART NO.	DESCRIPTION	QTY.
#1 Old	19060-13	Bonnet Seal	2
#1 New	46613-02	Bonnet Seal	2
#1 Cam Ram	644197-2	Bonnet Seal	2
#2 Old	12469-38	Ring, Plastic Packing	2
#3 Old	18586-18	Ring, Plastic Energizing	2
#4 Old	18492-91	O-ring, Operating Piston Rod to Int. Flange	2
#5 Old	18492-88	O-ring, Operating Piston	2
#5 New	704773	Lip Seal, Operating Piston	2
#6 Old	11741-33	Seal Ring, Tail Rod	2
#7 Old	11741-38	Ring, Connecting Rod	2
#8 Old	6227-29-13-85	O-ring, Ram Change Piston to Body	4
#9 Old	6227-78-13-85	O-ring, Operating Cylinder	4
#10 Old	6227-38-01-70	O-ring, Wiping	2
#11 Old	6227-34-13-85	O-ring, Ram Change Piston to Int. Flange	4
#12 Old	31423-25-13-85	O-ring, Ram Change Cylinder to Int. Flange	
		(6227-44-13-85)	4
#13 Old	31423-26-13-85	O-ring, Ram Change Cylinder to Bonnet	
		(6227-48-13-85)	4
#14 Old	6227-38-13-85	O-ring, Ram Change Piston	4
#15a Old	6230-05-13-85	O-ring, Bonnet Bolt Retainer 3000 psi	8
#15b Old	6230-07-13-85	O-ring, Bonnet Bolt Retainer 5000 psi	8
#15c Old	6230-12-13-85	O-ring, Bonnet Bolt Retainer 10000 psi	8

TO MAKE 11" SEAL KIT INTO REPAIR KIT INCLUDE #16 THRU #19:

STYLE	PART NO.	DESCRIPTION	QTY.
#16	21792-21	Back-up Ring	4
#17	49223-03	Wear Band	2
#18	2353-26	Washer	2
#19	18572-83	Retainer Ring	2
ITEMS #1-15		Complete Old Style Seal Kit (OS Bonnet)	
ITEMS #1-15		Complete Cam Ram Seal Kit (C/R Bonnet & NS Piston)	
ITEMS #1-19		Complete Old Style Repair Kit	
ITEMS #1-15		Complete Cam Ram Repair Kit	

Note: Individual parts can be quoted on request.

Seal and Repair Kits

Catalog EPS 5265

13-5/8" TYPE U SEAL KIT

STYLE	PART NO.	DESCRIPTION	QTY.
#1 Old	19060-11	Bonnet Seal	2
#1 New	46613-13	Bonnet Seal	2
#1 Cam Ram	644197-3	Bonnet Seal	2
#2 Old	12469-24	Ring, Plastic Packing	2
#3 Old	18586-01	Ring, Plastic Energizing	2
#4 Old	18492-90	O-ring, Operating Piston Rod to Int. Flange	2
#5 Old	18492-29	O-ring, Operating Piston	2
#5 New	704772	Lip Seal, Operating Piston	2
#6 Old	11741-34	Seal Ring, Tail Rod	2
#7 Old	11741-36	Ring, Connecting Rod	2
#8 Old	6227-31-13-85	O-ring, Ram Change Piston to Body	4
#9 Old	6227-82-13-85	O-ring, Operating Cylinder	4
#10 Old	6227-40-01-70	O-ring, Wiping	2
#11 Old	6227-36-13-85	O-ring, Ram Change Piston to Int. Flange	4
#12 Old	6227-49-13-85	O-ring, Ram Change Cylinder to Int. Flange	4
#13 Old	6227-88-13-85	O-ring, Ram Change Cylinder to Bonnet	4
#14 Old	6227-41-13-85	O-ring, Ram Change Piston	4
#15a Old	6230-09-13-85	O-ring, Bonnet Bolt Retainer 3000 psi	8
#15b Old	6230-10-01-90	O-ring, Bonnet Bolt Retainer 5000 psi	8
#15c Old	6230-17-13-85	O-ring, Bonnet Bolt Retainer 10000 psi	8

TO MAKE 13-5/8" SEAL KIT INTO REPAIR KIT INCLUDE #16 THRU #19:

STYLE	PART NO.	DESCRIPTION	QTY.
#16	21792-26	Back-up Ring	4
#17	49223-01	Wear Band	2
#18	689523-01	Washer	2
#19	18572-83	Retainer Ring	2
ITEMS #1-15		Complete Old Style Seal Kit (OS Bonnet)	
ITEMS #1-15		Complete Cam Ram Seal Kit (C/R Bonnet & NS Piston)	
ITEMS #1-19		Complete Old Style Repair Kit	
ITEMS #1-15		Complete Cam Ram Repair Kit	

Note: Individual parts can be quoted on request.

Seal and Repair Kits

Catalog EPS 5265

6" QRC RAM TYPE SEAL KIT

PART NO.	DESCRIPTION	QTY.	NOTES
19061-1	Bonnet Seal	2	
11741-1	Ring, Connecting Rod Seal	2	
11746-1	Ring, Plastic Packing Retainer	4	
11741-7	Ring, Operating Cylinder Head	4	
11741-4	Ring, Piston	4	
18493-12	Ring, Piston Rod Seal	4	
PQRC6-SKIT	6" QRC Seal Kit		

Note: Individual parts can be quoted on request.

GK SEAL KIT

PART NO.	SIZE
PGKS-7-3	7-1/16" 3M#
PGKS-7-5	7-1/16" 5M#
PGKS-11-3	11" 3M#
PGKS-11-5	7-5/8" 5M#
PGKS-13-3	13-5/8" 3M#
PGKS-13-5	13-5/8" 5M#

Note: Individual parts can be quoted on request.

MSP SEAL KIT

PART NO.	SIZE
PMSPS-7-2	7-1/16" 2M#
PMSPS-9-2	9" 2M#
PMSPS-11-2	11" 2M#
PMSPS-21-2	21-1/4" 2M#
PMSPS-29-05	29-1/2" 500#

Note: Individual parts can be quoted on request.

Seal and Repair Kits

RAM TYPE SEAL KIT

PART NO.	SIZE
PSRP-7-3	7-1/16" 3M# LWP
PSRS-7-5	7-1/16" 5M# LWS
PSRP-9-3	9" 3M# LWP
PSRS-11-5	11" 5M# LWS
PSRL-13-3-5	13-5/8" 3M-5M# SL
PSRL-13-10	13-5/8" 10M# SL
PSRL-11-10	11" 10M# SL W/14" CYL.
PSRLP-13-10	13-5/8" 10M# SL (Poslock Cyl.)
PSRSP-20-3	20-3/4" 3M# LWS (Poslock Cyl.) Note: 10" or 14" Cyl.
PSRSP-21-2	21-1/4" 2M# LWS (Poslock Cyl.) Note: 10" or 14" Cyl.

Note: Individual parts can be quoted on request.

SPHERICAL SEAL KIT

PART NO.	SIZE
PSSK-7-3 ST	7-1/16" 3M#
PSSK-7-5 ST	7-1/16" 5M#
PSSK-9-5 ST	9" 5M#
PSSK-11-5 ST	11" 5M#
PSSK-13-5 ST	13-5/8" 5M#
PSSK-21-2 ST	21-1/4" 2M#

Note: Individual parts can be quoted on request.

Miscellaneous

SWIVEL SEAT

PART NO.	SIZE
PKSS-15XV5	2"



RUBBER COATED RING GASKET

PART NO.	DESCRIPTION
PR-45	R-45
PR-46	R-46
PR-4546	R-45 & R-46 Combination

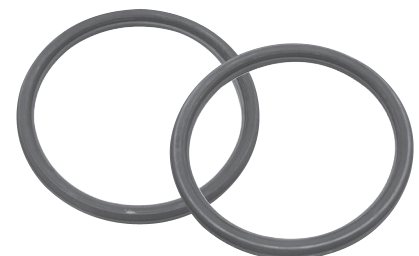

Swab Cups

Catalog EPS 5265

LIGHT LOAD ALL RUBBER SWAB CUPS

PART NO.	SIZE	SLEEVE	CUP OD
SDA-2	2-3/8"	Aluminum	1.970"
SDT-2	2-3/8"	Steel	1.970"
SDA-5	2-7/8"	Aluminum	2.400"
SDT-5	2-7/8"	Steel	2.400"
SDA-30	3-1/2"	Aluminum	2.960"
SDA-30	3-1/2"	Steel	2.960"



MEDIUM LOAD ALL RUBBER SWAB CUPS

PART NO.	SIZE	SLEEVE	CUP OD
A-154	1-1/2"R	Aluminum	1.580"
MST-154	1-1/2"R	Steel	1.580"
MAU-154	1-1/2"U	Aluminum	1.500"
MSTU-154	1-1/2"U	Steel	1.500"
MAU-216	2-1/16"U	Aluminum	1.660"
MSTU-216	2-1/16"U	Steel	1.660"
MA-2	2-3/8"R	Aluminum	1.960"
MST-2	2-3/8"R	Steel	1.960"
MAU-2	2-3/8"U	Aluminum	1.930"
MSTU-2	2-3/8"U	Steel	1.930"
MA-5	2-7/8"R	Aluminum	2.390"
MST-5	2-7/8"R	Steel	2.390"
MAU-5	2-7/8"U	Aluminum	2.350"
MSTU-5	2-7/8"U	Steel	2.350"
MA-30	3-1/2"R	Aluminum	2.930"
MST-30	3-1/2"R	Steel	2.930"



SUPER LOAD ALL RUBBER SWAB CUPS

PART NO.	SIZE	SLEEVE	CUP OD
SA-2	2-3/8"R	Aluminum	1.950"
ST-2	2-3/8"R	Steel	1.950"
USA-2	2-3/8"U	Aluminum	1.930"
UST-2	2-3/8"U	Steel	1.930"
SA-1	2-3/8" / 5.95 #PH-6	Aluminum	1.760"
ST-1	2-3/8" / 5.95 #PH-6	Steel	1.760"
SA-5	2-7/8"R	Aluminum	2.390"
ST-5	2-7/8"R	Steel	2.390"
USA-5	2-7/8"U	Aluminum	2.350"
UST-5	2-7/8"U	Steel	2.350"
SA-7	2-7/8" / 7.9 #PH-6	Aluminum	2.230"
ST-7	2-7/8" / 7.9 #PH-6	Steel	2.230"
SA-6	2-7/8" / 8.7 #PH-6	Aluminum	2.170"
ST-6	2-7/8" / 8.7 #PH-6	Steel	2.170"
SA-30	3-1/2"R	Aluminum	2.930"
ST-30	3-1/2"R	Steel	2.930"



Swab Cups

Catalog EPS 5265

SUPER LOAD WIRE SWAB CUPS

PART NO.	SIZE	SLEEVE	CUP OD
USW-2	2"	Undersize Wire	1.915"
USW-5	2-1/2"	Undersize Wire	2.340"
USW-30	3-1/2"	Undersize Wire	2.880"



V CUPS ALL RUBBER SWAB CUPS

PART NO.	SIZE	SLEEVE	CUP OD
SV-450	4-1/2"C	Steel	4.000"
SV-550	5-1/2"C	Steel	4.950"



Oil Saver Rubbers

TYPE "H" OIL SAVER

PART NO.	SIZE	DUROMETER
H916	3/8" - 5/8" Black	50-Duro
H916R	3/8" - 5/8" Red	40-Duro
H916B	3/8" - 5/8" Blue	40-Duro



Rod Strippers

DOUBLE "E" ROD STRIPPER

PART NO.	SIZE
EEBSR	1/2" - 1"



The items described in this document and other documents and descriptions provided by Parker Hannifin Corporation, its subsidiaries and its authorized distributors (“Seller”) are hereby offered for sale at prices to be established by Seller. This offer and its acceptance by any customer (“Buyer”) shall be governed by all of the following Terms and Conditions. Buyer’s order for any item described in its document, when communicated to Seller verbally, or in writing, shall constitute acceptance of this offer. All goods, services or work described will be referred to as “Products”.

1. Terms and Conditions. Seller’s willingness to offer Products, or accept an order for Products, to or from Buyer is subject to these Terms and Conditions or any newer version of the terms and conditions found on-line at www.parker.com/saleterms/. Seller objects to any contrary or additional terms or conditions of Buyer’s order or any other document issued by Buyer.
2. Price Adjustments; Payments. Prices stated on Seller’s quote or other documentation offered by Seller are valid for 30 days, and do not include any sales, use, or other taxes unless specifically stated. Unless otherwise specified by Seller, all prices are F.C.A. Seller’s facility (INCOTERMS 2010). Payment is subject to credit approval and is due 30 days from the date of invoice or such other term as required by Seller’s Credit Department, after which Buyer shall pay interest on any unpaid invoices at the rate of 1.5% per month or the maximum allowable rate under applicable law.
3. Delivery Dates; Title and Risk; Shipment. All delivery dates are approximate and Seller shall not be responsible for any damages resulting from any delay. Regardless of the manner of shipment, title to any products and risk of loss or damage shall pass to Buyer upon placement of the products with the shipment carrier at Seller’s facility. Unless otherwise stated, Seller may exercise its judgment in choosing the carrier and means of delivery. No deferment of shipment at Buyers’ request beyond the respective dates indicated will be made except on terms that will indemnify, defend and hold Seller harmless against all loss and additional expense. Buyer shall be responsible for any additional shipping charges incurred by Seller due to Buyer’s acts or omissions.
4. Warranty. Seller warrants that the Products sold hereunder shall be free from defects in material or workmanship for a period of twelve months from the date of delivery to Buyer or 2,000 hours of normal use, whichever occurs first. The prices charged for Seller’s products are based upon the exclusive limited warranty stated above, and upon the following disclaimer: **DISCLAIMER OF WARRANTY: THIS WARRANTY COMPRISES THE SOLE AND ENTIRE WARRANTY PERTAINING TO PRODUCTS PROVIDED HEREUNDER. SELLER DISCLAIMS ALL OTHER WARRANTIES, EXPRESS AND IMPLIED, INCLUDING DESIGN, MERCHANTABILITY AND FITNESS FOR A PARTICULAR PURPOSE.**
5. Claims; Commencement of Actions. Buyer shall promptly inspect all Products upon delivery. No claims for shortages will be allowed unless reported to the Seller within 10 days of delivery. No other claims against Seller will be allowed unless asserted in writing within 30 days after delivery. Buyer shall notify Seller of any alleged breach of warranty within 30 days after the date the defect is or should have been discovered by Buyer. Any action based upon breach of this agreement or upon any other claim arising out of this sale (other than an action by Seller for an amount due on any invoice) must be commenced within 12 months from the date of the breach without regard to the date breach is discovered.
6. LIMITATION OF LIABILITY. UPON NOTIFICATION, SELLER WILL, AT ITS OPTION, REPAIR OR REPLACE A DEFECTIVE PRODUCT, OR REFUND THE PURCHASE PRICE. IN NO EVENT SHALL SELLER BE LIABLE TO BUYER FOR ANY SPECIAL, INDIRECT, INCIDENTAL OR CONSEQUENTIAL DAMAGES ARISING OUT OF, OR AS THE RESULT OF, THE SALE, DELIVERY, NON-DELIVERY, SERVICING, USE OR LOSS OF USE OF THE PRODUCTS OR ANY PART THEREOF, OR FOR ANY CHARGES OR EXPENSES OF ANY NATURE INCURRED WITHOUT SELLER’S WRITTEN CONSENT, EVEN IF SELLER HAS BEEN NEGLIGENT, WHETHER IN CONTRACT, TORT OR OTHER LEGAL THEORY. IN NO EVENT SHALL SELLER’S LIABILITY UNDER ANY CLAIM MADE BY BUYER EXCEED THE PURCHASE PRICE OF THE PRODUCTS.
7. User Responsibility. The user, through its own analysis and testing, is solely responsible for making the final selection of the system and Product and assuring that all performance, endurance, maintenance, safety and warning requirements of the application are met. The user must analyze all aspects of the application and follow applicable industry standards and Product information. If Seller provides Product or system options, the user is responsible for determining that such data and specifications are suitable and sufficient for all applications and reasonably foreseeable uses of the Products or systems.
8. Loss to Buyer’s Property. Any designs, tools, patterns, materials, drawings, confidential information or equipment furnished by Buyer or any other items which become Buyer’s property, will be considered obsolete and may be destroyed by Seller after two consecutive years have elapsed without Buyer ordering the items manufactured using such property. Seller shall not be responsible for any loss or damage to such property while it is in Seller’s possession or control.
9. Special Tooling. A tooling charge may be imposed for any special tooling, including without limitation, dies, fixtures, molds and patterns, acquired to manufacture Products. Such special tooling shall be and remain Seller’s property notwithstanding payment of any charges by Buyer. In no event will Buyer acquire any interest in apparatus belonging to Seller which is utilized in the manufacture of the Products, even if such apparatus has been specially converted or adapted for such manufacture and notwithstanding any charges paid by Buyer. Unless otherwise agreed, Seller shall have the right to alter, discard or otherwise dispose of any special tooling or other property in its sole discretion at any time.
10. Buyer’s Obligation; Rights of Seller. To secure payment of all sums due or otherwise, Seller shall retain a security interest in the goods delivered and this agreement shall be deemed a Security Agreement under the Uniform Commercial Code. Buyer authorizes Seller as its attorney to execute and file on Buyer’s behalf all documents Seller deems necessary to perfect its security interest.
11. Improper use and Indemnity. Buyer shall indemnify, defend, and hold Seller harmless from any claim, liability, damages, lawsuits, and costs (including attorney fees), whether for personal injury, property damage, patent, trademark or copyright infringement or any other claim, brought by or incurred by Buyer, Buyer’s employees, or any other person, arising out of: (a) improper selection, improper application or other misuse of Products purchased by Buyer from Seller; (b) any act or omission, negligent or otherwise, of Buyer; (c) Seller’s use of patterns, plans, drawings, or specifications furnished by Buyer to manufacture Product; or (d) Buyer’s failure to comply with these terms and conditions. Seller shall not indemnify Buyer under any circumstance except as otherwise provided.
12. Cancellations and Changes. Orders shall not be subject to cancellation or change by Buyer for any reason, except with Seller’s written consent and upon terms that will indemnify, defend and hold Seller harmless against all direct, incidental and consequential loss or damage. Seller may change product features, specifications, designs and availability with notice to Buyer.
13. Limitation on Assignment. Buyer may not assign its rights or obligations under this agreement without the prior written consent of Seller.
14. Force Majeure. Seller does not assume the risk and shall not be liable for delay or failure to perform any of Seller’s obligations by reason of circumstances beyond the reasonable control of Seller (hereinafter “Events of Force Majeure”). Events of Force Majeure shall include without limitation: accidents, strikes or labor disputes, acts of any government or government agency, acts of nature, delays or failures in delivery from carriers or suppliers, shortages of materials, or any other cause beyond Seller’s reasonable control.
15. Waiver and Severability. Failure to enforce any provision of this agreement will not waive that provision nor will any such failure prejudice Seller’s right to enforce that provision in the future. Invalidation of any provision of this agreement by legislation or other rule of law shall not invalidate any other provision herein. The remaining provisions of this agreement will remain in full force and effect.
16. Termination. Seller may terminate this agreement for any reason and at any time by giving Buyer thirty (30) days written notice of termination. Seller may immediately terminate this agreement, in writing, if Buyer: (a) commits a breach of any provision of this agreement (b) appointments a trustee, receiver or custodian for all or any part of Buyer’s property (c) files a petition for relief in bankruptcy on its own behalf, or by a third party (d) makes an assignment for the benefit of creditors, or (e) dissolves or liquidates all or a majority of its assets.
17. Governing Law. This agreement and the sale and delivery of all Products hereunder shall be deemed to have taken place in and shall be governed and construed in accordance with the laws of the State of Ohio, as applicable to contracts executed and wholly performed therein and without regard to conflicts of laws principles. Buyer irrevocably agrees and consents to the exclusive jurisdiction and venue of the courts of Cuyahoga County, Ohio with respect to any dispute, controversy or claim arising out of or relating to this agreement.
18. Indemnity for Infringement of Intellectual Property Rights. Seller shall have no liability for infringement of any patents, trademarks, copyrights, trade dress, trade secrets or similar rights except as provided in this Section. Seller will defend and indemnify Buyer against allegations of infringement of U.S. patents, U.S. trademarks, copyrights, trade dress and trade secrets (“Intellectual Property Rights”). Seller will defend at its expense and will pay the cost of any settlement or damages awarded in an action brought against Buyer based on an allegation that a Product sold pursuant to this Agreement infringes the Intellectual Property Rights of a third party. Seller’s obligation to defend and indemnify Buyer is contingent on Buyer notifying Seller within ten (10) days after Buyer becomes aware of such allegations of infringement, and Seller having sole control over the defense of any allegations or actions including all negotiations for settlement or compromise. If a Product is subject to a claim that it infringes the Intellectual Property Rights of a third party, Seller may, at its sole expense and option, procure for Buyer the right to continue using the Product, replace or modify the Product so as to make it noninfringing, or offer to accept return of the Product and return the purchase price less a reasonable allowance for depreciation. Notwithstanding the foregoing, Seller shall have no liability for claims of infringement based on information provided by Buyer, or directed to Products delivered hereunder for which the designs are specified in whole or part by Buyer, or infringements resulting from the modification, combination or use in a system of any Product sold hereunder. The foregoing provisions of this Section shall constitute Seller’s sole and exclusive liability and Buyer’s sole and exclusive remedy for infringement of Intellectual Property Rights.
19. Entire Agreement. This agreement contains the entire agreement between the Buyer and Seller and constitutes the final, complete and exclusive expression of the terms of sale. All prior or contemporaneous written or oral agreements or negotiations with respect to the subject matter are herein merged.
20. Compliance with Law, U. K. Bribery Act and U.S. Foreign Corrupt Practices Act. Buyer agrees to comply with all applicable laws and regulations, including both those of the United Kingdom and the United States of America, and of the country or countries of the Territory in which Buyer may operate, including without limitation the U. K. Bribery Act, the U.S. Foreign Corrupt Practices Act (“FCPA”) and the U.S. Anti-Kickback Act (the “Anti-Kickback Act”), and agrees to indemnify and hold harmless Seller from the consequences of any violation of such provisions by Buyer, its employees or agents. Buyer acknowledges that they are familiar with the provisions of the U. K. Bribery Act, the FCPA and the Anti-Kickback Act, and certifies that Buyer will adhere to the requirements thereof. In particular, Buyer represents and agrees that Buyer shall not make any payment or give anything of value, directly or indirectly to any governmental official, any foreign political party or official thereof, any candidate for foreign political office, or any commercial entity or person, for the purpose of influencing such person to purchase products or otherwise benefit the business of Seller.

North America
EPS Division, Headquarters
Salt Lake City, Utah
phone 801 972 3000
fax 801 973 4019

Nacogdoches, Texas
phone 800 233 3900
fax 936 560 8998

Houston, Texas
phone 713 910 7700
fax 713 910 6600

Marion, New York
phone 315 926 4211
fax 315 926 4496

Elgin, Illinois
phone 847 783 4300
fax 847 783 4311

Baja, Mexico
phone 619 671 3257

Your Local Authorized Parker Distributor

Parker Hannifin Corporation
Engineered Polymer Systems Division
phone 800 233 3900

www.parker.com/eps

