

PARJET CO., LTD.



# PTFE Rotary Seals 鐵氟龍旋轉密封件

鐵氟龍翻唇式旋轉密封件 PTFE ROTARY LIP SEALS  
鐵氟龍彈簧密封件 SPRING ENERGIZED SEAL  
鐵氟龍旋轉液壓密封件 PTFE ROTARY GLIDE SEAL SET

 ISO 9001

 IATF 16949

 ISO 14001

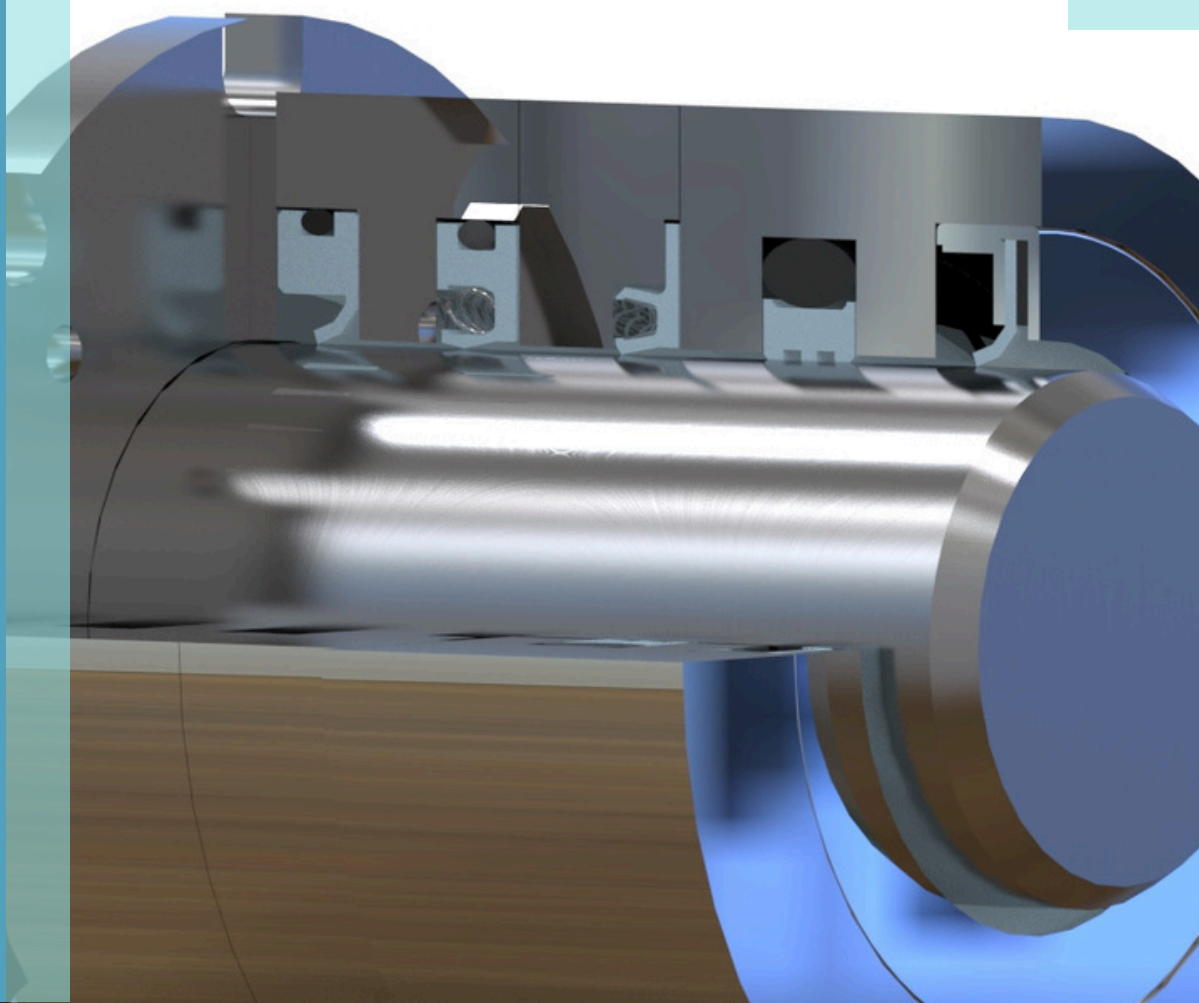

# PARJET

## 培凱有限公司

Parjet is an IATF 16949, ISO 9001 and ISO 14001 certified advanced seals manufacturer and distributor that supplies high-performance customized sealing components to FTSE 500 enterprises. We are one of the leading companies in manufacturing PTFE seals in Taiwan. We design, manufacture, and deliver various high quality sealing components to our customers around the globe. Parjet has an extensive inventory of PTFE seals, hydraulic seals, pneumatic seals, mechanical seals, bearing isolators, springs, O-rings, and more. We supply superior quality sealing solutions to more than 2100+ companies in over 30 countries worldwide, serving more than 15 industries including Automotive, Oil & Gas, Health & Medical, Food & Beverage, Semiconductor, valves and more.

### Our vision:

To help businesses create values, by one seal at a time.

培凱有限公司自1991年創社以來，通過 IATF 16949、ISO9001和ISO 14001 之認證並成為專業密封件供應商。我們服務超過15個產業，包括汽車、石油和天然氣、醫療、食品、半導體、閥門等產業。我們擁有豐富的應用經驗與實績，多年來不但引進國外工業密封解決方案，亦針對客戶需求，與國外顧問合作提升產品品質。培凱擁有完善的PTFE 密封件、液壓密封件、氣動密封件、機械密封件、軸承隔離器、彈簧、O型環等庫存，目前已經累積銷售到超過全球 30 多個國家、2100多家公司、15個產業。

### 我們的願景:

透過密封件來幫助企業創造價值。

### Product Offerings:

- **HiPerSeal**<sup>®</sup> - Spring Energized Seals
- **HiPerLip**<sup>®</sup> - PTFE Rotary Lip Seals with Metal Casing
- **HiPerFlon**<sup>®</sup> - PTFE Rotary Lip Seals with O Ring
- **ParSeries**<sup>®</sup> - Mechanical Seals, Lip Seals
- **ParSave**<sup>®</sup> - Bearing Isolators
- **PTFE Seals**
- **Wear Rings**
- **Springs**
- **Hydraulic Seals**  
..... and more

### 培凱產品項目:

- **HiPerSeal**<sup>®</sup> - 鐵氟龍彈簧密封件
- **HiPerLip**<sup>®</sup> - 鐵氟龍翻唇式旋轉密封件(搭配鐵殼)
- **HiPerFlon**<sup>®</sup> - 鐵氟龍翻唇式旋轉密封件(搭配O型環)
- **ParSeries**<sup>®</sup> - 機械軸封、唇封
- **ParSave**<sup>®</sup> - 軸承隔離器
- 鐵氟龍液壓密封件
- 耐磨環
- 彈簧
- 液壓油封  
..... 其他更多

# Table of Content

## 目錄

<b>Parjet PTFE Rotary Seals Overview</b> 培凱鐵氟龍旋轉密封件總覽	-----	03
<b>Rotary Seals Design Consideration</b> 旋轉密封件設計考量	-----	05
<b>HiPerLip®</b> PTFE Rotary Lip Seal with Metal Casing 鐵氟龍翻唇式旋轉密封件 (搭配鐵殼)	-----	09
Product Profile 產品形式	-----	12
<b>HiPerFlon®</b> PTFE Rotary Lip Seals with O Ring 鐵氟龍翻唇式旋轉密封件 (搭配O型環)	-----	18
Product Profile 產品形式	-----	21
<b>HiPerSeal®</b> Spring Energized Seals 鐵氟龍彈簧密封件	-----	25
Product Profile 產品形式	-----	28
<b>PTFE Glide Seal Set</b> 鐵氟龍旋轉液壓密封件	-----	32
Product Profile 產品形式	-----	33
<b>Material</b> 材料選項	-----	35
<b>Groove and Installation</b> 溝槽與安裝	-----	41

# Parjet PTFE Rotary Seals Overview

## 培凱鐵氟龍旋轉密封件總覽

Seals come in different forms and materials, from simple O Ring for static applications to hydraulic rubber seals for reciprocating purposes and rotary seals for more extreme operating conditions. Parjet has many years of experiences in providing sealing solutions. We specialize in dynamic sealing solutions and offer a wide variety of rotary seals. Here is an overview of the rotary seals that we offer:

密封件有不同的形式與設計，從廣泛熟知的 O 型環用於靜態應用到往復式運動的液壓橡膠密封件以及較適合在嚴苛環境下的旋轉密封件。培凱多年來提供專業的密封件解決方案，對於設計與生產旋轉應用的密封件擁有豐富的經驗與能力，以下是我們提供的鐵氟龍旋轉密封件總覽。

### HiPerFlon®

PTFE Rotary Lip Seal (O Ring)  
鐵氟龍翻唇式旋轉密封件 (搭配 O 型環)



- Low Pressure & Medium Speed
- Simple and Flexible Design
- Open Groove Required
- 低壓中等速度應用
- 簡單靈活設計
- 安裝於開放式溝槽

### HiPerLip®

PTFE Rotary Lip Seal (Metal Casing)  
鐵氟龍翻唇式旋轉密封件 (搭配鐵殼)

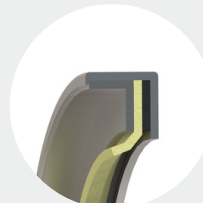

- Low Pressure & High Speed
- Open Groove Required
- 低壓高速度應用
- 安裝於開放式溝槽

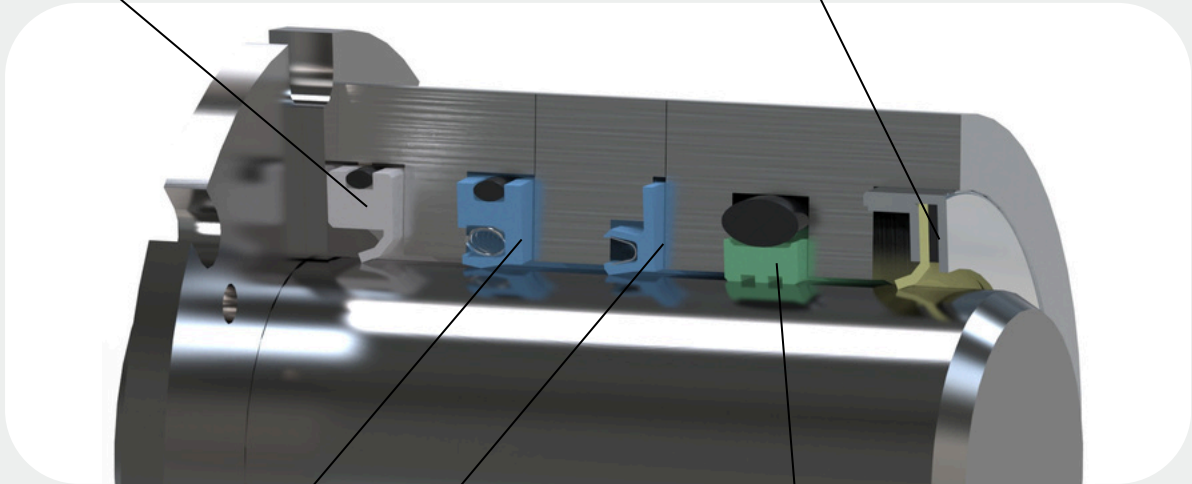

### HiPerSeal®

Spring Energized Seals  
鐵氟龍彈簧密封件

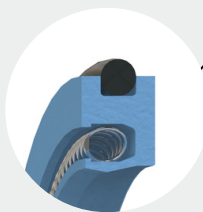

- High Pressure & Low Speed
- Wide Range of Spring Selection
- Open Groove Required
- 高壓低速度應用
- 廣泛彈簧選項
- 安裝於開放式溝槽

### PTFE Rotary Glide Seal Set 鐵氟龍旋轉液壓密封件

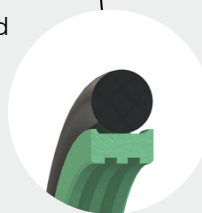

- High Pressure & Low Speed
- Applied for Bi-directional Pressure Applications
- Suitable for Closed Groove
- Suitable for Small Groove
- 高壓極低速度應用
- 適用於雙向壓力應用
- 可適用於一體式溝槽

The following summarizes the different types of sealing design and its suitable operating condition.

以下總結了不同密封件設計在旋轉應用中合適的工作條件:

速度 Speed  壓力 Pressure	低速 Low Speed < 5 m/s (< 984 fpm)	中速 Medium Speed 5 ~ 12.5 m/s (984fpm ~ 2460 fpm)	高速 High Speed 12.5 ~ 30 m/s (2460 fpm ~ 5905 fpm)			
	開放式溝槽 Open Grooves	一體式溝槽 Close Grooves	鐵殼 Metal	非鐵殼 Without Metal	鐵殼 Metal	非鐵殼 Without Metal
<b>低壓</b> Low Pressure < 10kg/cm <sup>2</sup> (< 14 psi)	HiPerFlon <sup>®</sup>	PTFE Glide Seal Set	HiPerLip <sup>®</sup>	HiPerFlon <sup>®</sup>	HiPerLip <sup>®</sup>	HiPerFlon <sup>®</sup>
<b>中壓</b> Medium Pressure 10 ~ 35kg/cm <sup>2</sup> (14 ~ 497 psi)	HiPerSeal <sup>®</sup>	PTFE Glide Seal Set	HiPerLip <sup>®</sup>		HiPerLip <sup>®</sup>	
<b>高壓</b> High Pressure > 35kg/cm <sup>2</sup> (> 497 psi)	HiPerSeal <sup>®</sup>	PTFE Glide Seal Set	For related demand, please consult with Parjet. 如有相關需求，歡迎與我們聯絡。			

### HiPerLip<sup>®</sup>

### HiPerFlon<sup>®</sup>

### HiPerSeal<sup>®</sup>

型式 Profile	壓力 Pressure				型式 Profile	壓力 Pressure		型式 Profile	法蘭式 Flange	斷面 Cross Section > 5mm (> 0.196")	斷面 Cross Section < 5mm (< 0.196")
	< 35 psi (< 2 bar)	35 ~ 75 psi (2 ~ 5 bar)	75 ~ 500 psi (5 ~ 34 bar)	500~ 750 psi (34 ~ 50 bar)		< 60 psi (< 4 bar)	< 150 psi (< 10 bar)				
標準 Standard	LA 	M1 	K2 	S2 	標準 Standard	NA 	NC 	標準型 Standard	VD 	VH 	VL 
防塵 With Wiper	LW 	MW 	KW 	SW 	防塵 With Wiper	NF 			CD 	CH 	CL 
左旋 Anti - clockwise		ML 	KL 		偏擺 Runout	ND 	NE 		HD 		
右旋 Clockwise		MR 	KR 		雙向唇 Double - acting Lip	NK 					
偏擺 Runout	LS 	MS 	KS 		雙向 + 防塵 Double acting lip with Wiper	NI 	NJ 				
偏擺 + 防塵 Runout with Wiper	LD 	MD 	KD 		軸徑大於 100mm 或 溫度 > 120 °C 或 < -15 °C 需支撐鐵環 Shaft diameter > 100mm or Temperature > 120 °C or < -15 °C Requires Supporting Ring				VDW 	VHW 	VLW 
雙向唇 Double - acting Lip			KB 	SB 							
食品級 Food Application		MA 	KA 		撐鐵環 Supporting Ring	NI 	NJ 	刮塵環 With Wiper	CDTW 	CHTW 	CLTW 

# Rotary Seals Design Consideration

## 旋轉密封件設計考量

When choosing and designing the right rotary seal, thorough consideration is required. One thing that differentiates rotary and reciprocating applications is the **concentration of the stresses**. For rotary sealing applications, the stress will be concentrated in a specific contact area where localized heat, wear and friction can accelerate the wear of the seals.

There are several factors that can influence the sealing performance, including groove, hardware design, operating conditions and seal design. Therefore, it is essential to understand those factors in detail in order to select and build the right sealing solution for your application. In this first section, we will explain few important aspects that should be taken into consideration when designing the right rotary seal.

### Factors that influence sealing performance:

1. Pressure vs. Velocity (PV limit)
2. Leakage vs. Torque
3. Hardware Design
4. Material Selection

在設計與選用適合的旋轉密封件上，需要多方面特殊的考量。旋轉與往復式應用不同的地方在於**應力的集中**。在旋轉應用的密封環境裡，能量會集中在接觸的區域，而這個範圍在運轉下產生的熱能、摩擦和磨耗會加速密封件的磨損。

許多因素會影響到密封件的性能，包含溝槽與轉軸的架構、工作環境條件及密封件本體的設計。需要先了解影響密封性能的因素，才有助於在設計與選擇密封件上打造出最適合的密封解決方案。因此，在深入了解的鐵氟龍旋轉唇形密封件前，我們首先會探討在設計密封件之前需要列入考量的重點。

### 影響密封性能的因素有:

1. 壓力 vs. 速度 (PV限值)
2. 洩漏 vs. 摩擦力
3. 硬件設計
4. 密封件材料選項



# 1. Pressure vs. Velocity (PV limit)

## 壓力 vs. 速度 (PV限值)

When selecting the right seal for your application, media pressure and surface speed are the key to the decision. The PV value represents the combination of pressure and speed one seal can bear. When the tolerable speed increases, the tolerable pressure will decrease. The PV limit represents the combination of the maximum speed and pressure a seal can withstand under light to normal wear. When the PV exceeds the limit, the seal will wear excessively and cause the sealing performance to fail.

Based on different seal design concepts, each form has its own corresponding PV limits. Some are designed for low pressure and high speed whereas others are made for high pressure and low speed environments. Below shows a summary of different types of sealing design and its suitable application.

在為您的應用選擇最合適的密封件時，介質壓力和表面速度是決策的關鍵。PV值代表著密封件承受壓力與速度的組合，當可承受速度上升時候，可耐的壓力就會下降。PV限值(PV limit)代表了在輕至正常的磨耗程度下，可承受最高速度與壓力的組合。換句話說，密封件在PV限值內可以正常運作，但當PV超過了極限值，密封件會過度磨損，導致密封性能失效。除了壓力與速度之外，實際的PV限值也會被其他因素影響，例如，潤滑油、表面粗糙度、溫度...等。

隨著不同的密封件設計理念，不同類型的密封件會有相對應的PV限值，有些密封件專為低壓高速的應用設計，而有些密封件可承受更高壓卻低速的環境。以下統整了不同類型的密封件設計及其合適的應用。

	HiPerLip®	HiPerFlon®	HiPerSeal®	
				
	PTFE Rotary Lip Seal with Metal Casing 鐵氟龍翻唇式旋轉密封件 (搭配鐵殼)	PTFE Rotary Lip Seal with O Ring 鐵氟龍翻唇式旋轉密封件 (搭配O型環)	Spring Energized Seals 鐵氟龍彈簧密封件	PTFE Glide Seal Set 鐵氟龍液壓密封件
<b>Pressure</b> 壓力	Low 低	Low 低	High 高	High 高
<b>Speed</b> 速度	High 高	Medium 中等	Low 低	Very low 極低

HiPerLip® and HiPerFlon® utilize a sealing lip design without a spring energizer, which can reduce friction and heat in applications with medium to high speeds. These seals are ideal for surface speeds above 5 m/s (980 fpm) and pressures below 35 Bar (500 psi). For pressures above 35 Bar (500 psi), the sealing lips can be damaged and a spring energized HiPerSeal® or PTFE Glide Seal Set would be more applicable. The seal geometry of the the seals is what makes this seal better suited for high pressures. However, the sealing friction and heat generated due to the additional pressures limit the maximum surface speed for these seals.

If your application requires both high pressure and high speed, please contact us and we will advise you on the best solution.

由於HiPerLip® 與HiPerFlon® 的密封唇較薄，可在中至高的轉速減少摩擦與熱能，提高密封性能，但是在高壓的環境下容易破損。所以當壓力超過 35 bar (500psi)，專為低壓旋轉應用設計的HiPerLip®與HiPerFlon® 將不適用。在這種工況下，彈簧密封件HiPerSeal® 或鐵氟龍液壓密封件會更合適。HiPerSeal® 的彈簧在高壓下會撐開油封，助於緊密封，然而，密封摩擦與熱能會藉此增加，限制承受表面速度的最大值。因此如果當表面速度超過5m/s(980 fpm)、壓力低於35 bar(500 psi)時，可優先考慮HiPerLip® 與HiPerFlon®。

如果同時有高速與高壓的應用，可與我們聯繫，我們能為您提供專業的諮詢。

## 2. Leakage vs. Torque

### 洩漏 vs. 扭矩

Seals should have minimal movement in the hardware gland. Seal rotation can cause inconsistent torque, higher friction and wear which results in potential leakage through the seal OD. **Rotary seal designs are a balancing act between friction (torque) and seal performance (leakage).** Higher torque produces better sealing performance, but it can also lead to higher wear and lower sealing life. Conversely, lower torque reduces friction and longer sealing life but may have a higher leakage potential. Our engineering team will advise you with the most optimal design that minimizes both the leakage and torque.

密封件不應該在轉軸上移動。如果密封件在轉軸上移動，就會導致扭矩不一致、造成更高的摩擦和磨損，密封件的外徑就有可能會洩漏。**旋轉密封件的設計取決於摩擦(扭矩)和密封效果(洩漏)之間的平衡。** 扭矩越大，密封性能越好；但它會導致更高的磨損與更短的密封壽命。另一方面，較低的扭矩會減少摩擦並延長密封壽命，但也有較高的洩漏可能性。我們的工程團隊將為您提供最優化的設計建議，盡可能地減少洩漏和扭矩。

## 3. Hardware Design

### 硬件設計

The **roughness** and **hardness** of the shaft surface are important to a rotary seal performance.

#### Roughness

Roughness represents the unevenness of the mating surface. The smoother the shaft, the smaller the gap between the seal and the shaft.

轉軸表面的**粗糙度**和**硬度**對旋轉密封件的性能有著很大的影響。

#### 粗糙度

粗糙度代表著表面的不平等。當轉軸越光滑，密封件與轉軸之間間隙就會越小。

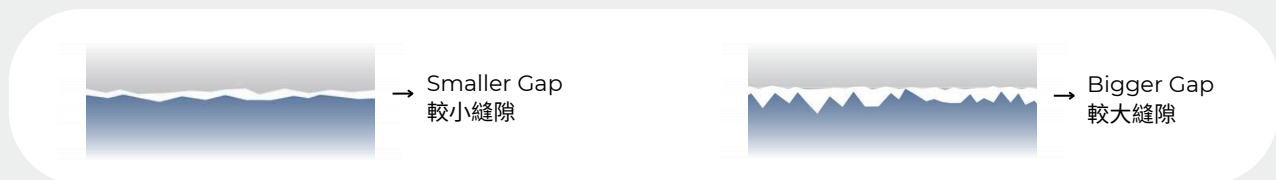

A smoother surface allows better sealing performance by reducing wear and increasing sealing life. Whereas a shaft with high surface roughness will cause leakage through the low points on the shaft surface, and excessive seal wear leading to premature seal failure. When it comes to elastomeric materials, a very smooth mating surface for dynamic application can actually decrease the effectiveness of an elastomeric seal. This is because the adhesive friction of elastomers increases as the area of contact increases. The lubricant film that is required for elastomers will be unable to flow through the seal contact area and the seal wears out faster. However, PTFE compound does not act the same as elastomers. Due to the nonstick property of PTFE material, the adhesive friction will decrease when the shaft surface is improved. As the friction reduces, so does the seal wear and heat generation. Therefore, when considering the design for PTFE rotary seals, a smoother surface finish is encouraged.

光滑的表面會降低密封件的磨損，達成更好的密封性能，最終延長密封壽命。另一方面，在表面粗糙度高的轉軸下，轉軸面與密封件之間的空隙較容易造成洩漏，同時也迅速磨損密封件並導致密封件失效。但是在橡膠材料來說，在動態的應用之下，太光滑的轉軸會降低密封性能，因為橡膠油封的摩擦力會隨著接觸面積的增加而增長。同時，在有用到潤滑油的情況下，潤滑油膜會無法在表面過於光滑的轉軸上流過密封接觸的區域，使得密封件磨損得更快。然而，培凱選用的鐵氟龍材質與傳統橡膠不同，它具有不粘、自潤的特性，所以當表面粗糙度下降時，粘附摩擦力並不會增加，整體的摩擦力反而會更小，油封磨損及摩擦產生的熱能也會隨著減少。因此，在考慮鐵氟龍旋轉密封件的設計時，會鼓勵使用更光滑的硬件。



## Hardness

**Hardness** is measured with the Rockwell C scale. The seal material is softer than the shaft, but the fillers used can still cause damage if the shaft is not hard enough. Harder shaft surfaces allow more material options for users, and the use of fillers with better wear resistance will increase the seal life. Some PTFE fillers used can be quite abrasive and may not be appropriate for soft shafts. During the initial wear in of a seal, it will polish the shaft surface and then the friction and wear will decrease over time. When the shaft hardness exceeds 40 to 50 Rockwell C, it will be harder to polish, and the seal will experience more wear. Therefore, as the hardness of the rotary shaft increases the mating surface finish needs to be smoother.

The **Roughness** and **Hardness** of the shaft are interdependent and directly affect the sealing performance. Ideally, the harder the surface and smoother the finish, the longer the seal life and better the seal performance. For more shaft surface recommendation, please refer to P.41.

## 4. Material Selection

### 密封件材質

For rotary applications, the seal material choice has the most bearing on the seal performance. The ultimate goal is to choose a material that is wear resistant yet flexible enough to prevent leakage on a high-speed shaft. Other aspects that influence the choice of material include chemical compatibility, mating-surface hardness requirement, FDA regulation, torque requirement, temperature, friction requirements and radiation exposure. The selection of the seal material can be limited by the hardware. For example, to maximize seal life and minimize wear in medium load hydraulic applications, one of the harder materials like 10T should be used. This material has excellent wear resistance, but the glass fiber filler can damage a softer shaft. Hence, with these materials, the shaft should have a hardness value above 45+ HRC. In case you are not sure about the best material for your application, our engineering team will assist you with the selection of materials.

For further material information please refer to P. 35.

## 硬度

硬度是由 Hardness Rockwell C (HRC) 標準測量。密封元件應該要比轉軸更軟，這樣才能防止密封件破壞轉軸表面。較硬的轉軸也讓使用者有更多的材料選擇，例如，某些鐵氟龍填料較耐用且強韌，就會不適用於較軟的轉軸。在磨合期的階段，密封件會拋光軸表面，然後隨著時間，表面變得較光滑後，摩擦和磨耗會逐漸減少。但當轉軸硬度超過 40 至 50 HRC 時，拋光會變得比較困難，如果加上粗糙度高的表面，很容易在剛開始拋光的階段就磨損密封件。因此，隨著轉軸硬度的增加，表面也要配合得更光滑。

轉軸的**粗糙度**和**硬度**與密封件性能息息相關，也需要互相配合。在理想的狀態下，越硬的轉軸與較光滑的表面下可以延長密封件壽命與效果。更多加工粗糙度與硬度的建議準則可參考 P.41。

在旋轉應用中，密封件材料的選擇對密封性能影響最大。要有效地在高速旋轉下防止轉軸洩漏，就是要選擇一種耐磨，但又夠柔韌的材料。其他影響材料選擇的因素也有包括化學相容性、表面硬度、FDA要求、扭矩要求、溫度、摩擦要求和輻射暴露...等。密封材料與添加物也會被硬件的設計受到限制，比如，在中等壓力液壓密封的應用中，要求密封壽命與耐磨特性的條件之下，鐵氟龍密封唇應該要用較硬的材料。10T有出色的耐磨性，但是裡面添加的玻璃纖維可能會磨損較軟的表面，所以這類的材質就只適用於表面硬度HRC 45以上的轉軸。

若有任何相關的需求，歡迎與我們聯絡，我們的工程團隊將協助您選用最適合的材料。

詳細完整材料說明，請參閱P. 36材料表。



# HiPerLip®

## PTFE Rotary Lip Seal with Metal Casing

### 鐵氟龍翻唇式旋轉密封件 (搭配鐵殼)

HiPerLip® is a rotary shaft seal with a PTFE sealing lip on the ID and metal casing on the OD, which is then press-fit into your housing. It is ideal for sealing high-speed rotary applications with very low friction and minimal power draw to achieve better performance, higher response, and precision. Since the lips are not energized by a spring, the contact pressure for the HiPerLip® is lower and the seal can function at much higher speeds. With many excellent PTFE compounds and the unique sealing lip geometries, the HiPerLip® provides superior performance over conventional rotary oil seals. This is especially true in very high-speed rotary, poorly lubricated, highly corrosive, high temperatures, and other extreme working environments. Applicable temperatures range from -60°C to 225°C (-76°F to 437°F) with surface speeds up to 30m/s (5900 fpm) at low or no pressure. The capabilities of the HiPerLip® far outperform common elastomers rotary seals.

The radial contact pressure of the HiPerLip® sealing lip produces leak tight sealing action on the shaft. This is achieved by a combination of correct PTFE seal lip geometry, static seal (gasket), precise steel casing and forming process. The wide selection of standard PTFE material, gasket and metal can be customized to suit almost any application. The interference is compliant with that specified in DIN 3760, and ensures static sealing between steel casing of HiPerLip® and the seal housing. Our standard steel casing material is mild steel (SPCD) but other materials like stainless steel (JIS SUS 304, SUS 316, DIN 1.4301) are available upon request.

HiPerLip® 為搭配鐵殼的鐵氟龍翻唇式旋轉密封件，俗稱鐵殼油封，由內徑鐵氟龍密封唇與外徑金屬鐵殼所組成的。具有低摩擦、低耗能的優異特性，可滿足設備的高應答、高精度性能要求。得益於優異的鐵氟龍材質特質跟獨特的密封唇結構，提供優於傳統油封的性能，適於高速、低壓、潤滑不良、高溫、及高腐蝕性流體等環境的應用。由於HiPerLip® 鐵氟龍唇部未有彈簧加力，接觸壓力相對於旋轉彈簧密封件還要來的低，因此，此密封件可以承受較高的轉速。使用溫度範圍可由-60°C至225°C (-76°F to 437°F)，在低壓的應用旋轉速度可高達30m/s (5900 fpm)，遠超過DIN3760的常用徑向旋轉密封件的材質（如NBR、ACM、FPM、VITON）等，其低摩擦特性可以減少摩擦熱，避免潤滑油脂碳化。

HiPerLip® 柔軟的鐵氟龍密封唇壓在轉軸上，在精密沖壓成型鋼環的支撐下，形成穩定的徑向接觸壓力，加上靜態密封墊片(Gasket)，可發揮優異的旋轉密封性能。標準鐵氟龍材料、密封墊和金屬外殼擁有廣泛的範圍選項，可進行客製化來滿足幾乎任何應用。其溝槽尺寸也符合DIN 3760標準，可完全取代傳統油封。HiPerLip® 的標準鋼環材質為碳鋼(SPCD)，亦可依客戶需求與應用條件，選用不銹鋼(JIS SUS 304, JIS SUS 316, DIN 1.4301) 等其他材質。

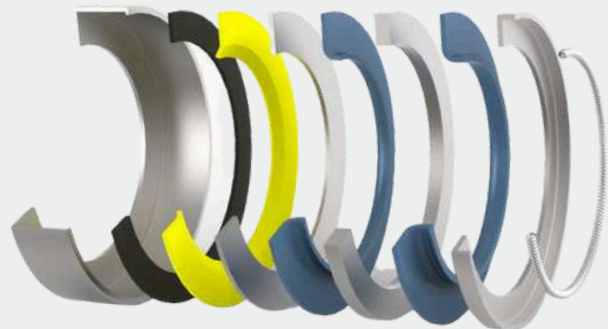

## HiPerLip® Component

### 鐵氟龍翻唇式旋轉密封件 (搭配鐵殼) 元件

Based on the different operating conditions and designs, the HiPerLip® can have different components. Each HiPerLip® will consist of one or more sealing lips, metal spacers and metal outer case. Gaskets can be adjusted based on different applications. Few applications might require a spring load.

HiPerLip®可以根據不同的工況條件進行客製化的設計。每個鐵殼油封將由至少一個密封唇、金屬墊片和金屬外殼所組成。靜態密封墊片可以依照不同的應用進行調整，少數的應用可能需要彈簧加力的設計。

#### Metal Spacer/Retaining Ring/ Inner Case

- Provides space for the sealing lip(s) to form curved shape.
- Also used to provide space between HiPerLip® designs with multiple sealing lips that face in the same direction.
- Acts as spacer to keep the lip edge away from the gland wall.

#### 金屬內殼/墊片

- 將2個朝向同個方向的密封唇分開
- 為密封唇提供彎曲空間
- 防止密封唇往內變形
- 將密封唇固定到位

#### Gasket

- Prevents the sealing media leak between the HiPerLip® components.
- Prevent the sealing component from falling off
- It can be eliminated based on working conditions (operating temperature, fluid media, etc).
- Made of elastomers

#### 靜態密封墊片

- 防止密封介質洩漏到外殼內部
- 防止密封唇脫落
- 可根據工況條件（工作溫度、流體介質、成本...等）選擇移除
- 橡膠材質為主

#### Paint Coating

- Applied to the OD of outer case for tighter sealing of air or light gases applications.
- Prevents scratches on the directly on the metal case.

#### 噴漆

- 適用於需要更緊密密封空氣或輕氣體的應用
- 塗抹在金屬外殼外徑
- 防止直接刮損鐵殼

#### Outer case

- Press fit into housing and prevents the seal from rotating with the shaft.
- Holds all the components inside the seal in place.
- Tailor made to fit in the sealing housing.

#### 金屬外殼

- 防止密封件隨著轉軸轉動
- 將密封件內的所有組件固定到位
- 量身定制以適合密封外殼

#### Garter Spring

- Provides additional spring load to compensate for shaft runout or shaft misalignment.
- Improves sealing under high speed.

#### 拉伸彈簧

- 在轉軸真圓度不佳或偏擺較大的應用下，提供輔助
- 提高高速下的密封性

#### Sealing lip (element)

- Press directly against the rotating shaft to prevent contaminants and leakage.
- The selection of sealing lip materials will depend on the application.
- Uses PTFE based materials compounded with wear resistant fillers.

#### 密封唇/元件

- 直接緊貼在旋轉的軸上，主要用於防污染物與止漏
- 密封唇的材質會取決於應用工況
- 鐵氟龍材質為主

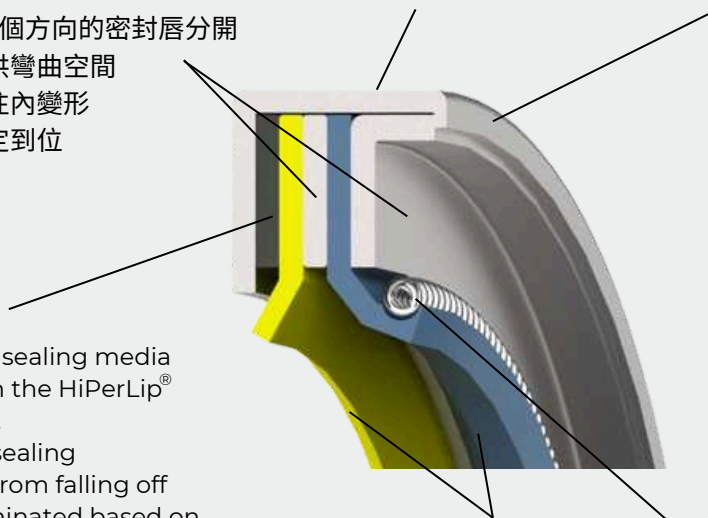

## Benefits of HiPerLip®

### 鐵氟龍翻唇式旋轉密封件 (搭配鐵殼) 的優點

#### 1. High speed and low to medium pressure applications.

HiPerLip® can operate at speeds up to 10.2 m/s (2000 fpm) at pressures up to 35 bar (250psi); and speeds up to 30m/s (6000 fpm) at low or no pressure. It performs best with well lubricated environments, but it is perfectly capable of sealing in dry applications.

#### 2. Anti-Rotation

HiPerLip® is pressed to fit into the housing therefore it does not rotate with the shaft. This prevents potential leakage across the OD.

#### 3. Corrosion resistance

The PTFE sealing lip material has excellent resistance to corrosive media (with pH above 4 and below 12.5) even at extreme temperatures and pressures. The metal casing can also be made from erosion resistant material such as high nickel alloys (Hastelloy®) for better corrosion resistance.

#### 4. Cryogenic and high temp. resistance

Operating in an environment up to 225°C (437°F) or at -60°C (-76°F), the sealing lips have twice the strength of traditional elastomeric materials and do not struggle from heat-aging or degradation.

#### 5. Abrasion Resistance

Some traditional elastomeric materials require lubricated oil fillers which could impact negatively on the material properties and reduce sealing life. The HiPerLip® sealing lip eliminates this issue and allows it to operate under both dry running and poorly lubricated conditions.

#### 6. Low friction characteristics prevent oil carbonization

HiPerLip® has very low break-out and dynamic friction even after long down-times. The PTFE compound has a low coefficient of friction (three times lower than elastomers) which reduces heat generated from the interaction with the shaft and prevents oil carbonization.

#### 1. 適用於高速與中~低壓力應用

HiPerLip® 能夠在35 bar (250 psi)的環境下，以高達 10.2m/s (2000 fpm) 的速度運轉，且低壓或無壓力的環境下，最高可耐的速度高達 30m/s (6000 fpm)。HiPerLip® 在良好潤滑的環境下可達成最佳的密封性能，但在無潤滑的環境下，也可以達成優良的止漏效果

#### 2. 防止密封件旋轉

HiPerLip® 可直接安裝於符合DIN 3760的密封溝槽。藉由外鐵殼的設計，在安裝的時候會被壓入溝槽內，所以當轉軸開始旋轉時，密封件不會跟著旋轉，防止外徑洩漏的問題。

#### 3. 防腐蝕性

鐵氟龍密封唇材質具有優異的耐化學性，即使在低溫和高溫下對pH值高於4和低於12.5的腐蝕性介質具有出色的耐受性。金屬鐵殼也可以搭配耐腐蝕材料，例如高鎳合金 (Hastelloy®)，以提高整體密封件的耐腐蝕性。

#### 4. 優良的耐高低溫特性

在高達 225°C (437°F) 的環境中，HiPerLip® 密封唇的強度是傳統彈性材料的兩倍，並且不會因熱老化或變形而失效。即使在 -60°C (-76°F) 的低溫環境下，也不會因低溫產生裂痕的情況。

#### 5. 優良的耐磨性



HiPerLip® 適用於短期無潤滑或長期潤滑不良的旋轉應用。一些傳統橡膠油封會需要潤滑油填料來解決磨耗問題，但這可能會對材料物性產生負面影響並縮短密封壽命。HiPerLip® 使用具有自潤滑和低摩擦特性的鐵氟龍材料能夠消除這個問題，讓使用壽命變長。

#### 6. 低摩擦特性防止油碳化

HiPerLip® 在啟動與運轉的時候，摩擦力極低，即使在長期停機後再度啟用，也能立即擁有低摩擦特性。鐵氟龍材質具有低摩擦係數(比傳統橡膠低了3倍)，可減少與轉軸之間產生的熱能並防止油碳化。

## HiPerLip® - Product Profiles

### 鐵氟龍唇式旋轉密封件(搭配鐵殼)型式







Profile 型式	Operating Condition 運轉條件			
	Press. 壓力	Temp. 溫度	Speed 速度	
LA		≤ 2 bar (35 psi)	- 40 °C to 200 °C (- 40 °F to 392 °F)	≤ 30 m/s (5900 fpm)
M1		≤ 5 bar (75 psi)	- 40 °C to 200 °C (- 40 °F to 392 °F)	≤ 25.4 m/s (5000 fpm)
K2		≤ 17.25 bar (250 psi)	- 40 °C to 200 °C (- 40 °F to 392 °F)	≤ 25.4 m/s (5000 fpm)
S2		≤ 35 bar (500 psi)	- 40 °C to 200 °C (- 40 °F to 392 °F)	≤ 25.4 m/s (5000 fpm)
LW		≤ 2 bar (35 psi)	- 40 °C to 200 °C (- 40 °F to 392 °F)	≤ 30 m/s (5900 fpm)
MW		≤ 5 bar (75 psi)	- 40 °C to 200 °C (- 40 °F to 392 °F)	≤ 25.4 m/s (5000 fpm)

For other operating conditions, please contact us.  
如有其他工況需求，歡迎與我們聯絡

<b>Features</b> 特性	<b>Applications</b> 應用
Machined primary lip 低摩擦加工單密封唇型	<ul style="list-style-type: none"> <li>• Low breakaway torque</li> <li>• Suitable for various anti-friction bearing sealing applications</li> <li>• 很適用於軸承保護用，且可完全取代傳統橡膠油封</li> <li>• 一般低起步扭矩的旋轉軸應用</li> </ul>
Standard formed primary lip 標準單密封唇型	<ul style="list-style-type: none"> <li>• General rotary applications</li> <li>• Suitable for fans, pumps, compressors, gear-boxes</li> <li>• 一般通用旋轉應用</li> <li>• 適用於風車、泵浦、壓縮機、齒輪箱、引擎曲軸箱等應用</li> </ul>
Dual primary lips 雙密封唇型	<ul style="list-style-type: none"> <li>• Low leakage systems</li> <li>• Suitable for hydraulic motors and hydraulic oil components applications</li> <li>• 可使用於低洩漏系統</li> <li>• 適用油壓馬達、液壓油元件等應用</li> </ul>
Dual primary lips seal with special design on metal backup washer 高壓型雙密封唇搭配特製金屬備圈	<ul style="list-style-type: none"> <li>• Low leakage systems</li> <li>• Suitable for higher pressure application</li> <li>• 可使用於低洩漏系統</li> <li>• 適用於高壓的環境下</li> </ul>
Machined primary lip (with wiper) 加工單密封唇型 (加上防塵)	<ul style="list-style-type: none"> <li>• Low breakaway torque</li> <li>• Suitable for various anti-friction bearing sealing applications</li> <li>• Additional dust extruder to protect primary seal lip</li> <li>• 很適用於軸承保護用，且可完全取代傳統橡膠油封</li> <li>• 一般低起步扭矩的旋轉軸應用</li> <li>• 可應用於多粉塵環境</li> </ul>
Standard formed primary lip (with wiper) 標準單唇型(加上防塵)	<ul style="list-style-type: none"> <li>• Low breakaway torque</li> <li>• Suitable for various anti-friction bearing sealing applications</li> <li>• Additional dust extruder to protect primary seal lip</li> <li>• 一般通用旋轉應用</li> <li>• 適用於風車、泵浦、壓縮機、齒輪箱、引擎曲軸箱等應用</li> <li>• 可應用於多粉塵環境</li> </ul>

# HiPerLip® - Product Profiles

## 鐵氟龍唇式旋轉密封件(搭配鐵殼)型式

Profile 型式	Operating Condition 運轉條件		
	Press. 壓力	Temp. 溫度	Speed 速度
<b>KW</b> 	≤ 17.25 bar (250 psi)	- 40 °C to 200 °C (- 40 °F to 392 °F)	≤ 25.4 m/s (5000 fpm)
<b>SW</b> 	≤ 35 bar (500 psi)	- 40 °C to 200 °C (- 40 °F to 392 °F)	≤ 25.4 m/s (5000 fpm)
<b>LS</b> 	≤ 5 bar (75 psi)	- 40 °C to 200 °C (- 40 °F to 392 °F)	≤ 10.2 m/s (2000 fpm)
<b>MS</b> 	≤ 8 bar (125 psi)	- 40 °C to 200 °C (- 40 °F to 392 °F)	≤ 10.2 m/s (2000 fpm)
<b>KS</b> 	≤ 17.25 bar (250 psi)	- 40 °C to 200 °C (- 40 °F to 392 °F)	≤ 10.2 m/s (2000 fpm)
<b>LD</b> 	≤ 5 bar (75 psi)	- 40 °C to 200 °C (- 40 °F to 392 °F)	≤ 10.2 m/s (2000 fpm)







For other operating conditions, please contact us.  
如有其他工況需求，歡迎與我們聯絡



<b>Features</b> 特性	<b>Applications</b> 應用
Dual primary lips (with wiper) 雙密封唇型(加上防塵)	<ul style="list-style-type: none"> <li>• Low leakage systems</li> <li>• Suitable for hydraulic motors and hydraulic oil components applications</li> <li>• Additional dust extruder to protect primary seal lip</li> <li>• 可使用於低洩漏系統</li> <li>• 適用油壓馬達、液壓油元件等應用</li> <li>• 可應用於多粉塵環境</li> </ul>
Dual primary lips seal with special design on metal backup washer (with wiper) 高壓型雙密封唇搭配特製金屬備圈 (加上防塵)	<ul style="list-style-type: none"> <li>• Low leakage systems</li> <li>• Suitable for higher pressure application</li> <li>• Additional dust extruder to protect primary seal lip</li> <li>• 可使用於低洩漏系統</li> <li>• 適用於高壓的環境下</li> <li>• 可應用於多粉塵環境</li> </ul>
Primary lip energized with Spring 加工單密封唇型(加彈簧)	<ul style="list-style-type: none"> <li>• Suitable for poor roundness or high round-out shaft</li> <li>• Low breakaway torque</li> <li>• Suitable when abrasive media is used</li> <li>• 適用於轉軸真圓度不佳或偏擺較大的場合</li> <li>• 一般低起步扭矩的旋轉軸應用</li> <li>• 適用於有腐蝕性介質應用</li> </ul>
Standard formed primary lip with Spring 標準單密封唇型(加彈簧)	<ul style="list-style-type: none"> <li>• Suitable for poor roundness or high round-out shaft</li> <li>• Suitable when abrasive media is used</li> <li>• 適用於轉軸真圓度不佳或偏擺較大的場合</li> <li>• 適用於有腐蝕性介質應用</li> </ul>
Dual formed primary lip with Spring 雙密封唇型(加彈簧)	<ul style="list-style-type: none"> <li>• Suitable for poor roundness or high round-out shaft</li> <li>• Suitable when abrasive media is used</li> <li>• 適用於轉軸真圓度不佳或偏擺較大的場合</li> <li>• 適用於有腐蝕性介質應用</li> </ul>
Primary lip energized with Spring and Wiper 加工單密封唇型(加彈簧、防塵)	<ul style="list-style-type: none"> <li>• Suitable for poor roundness or high round-out shaft</li> <li>• Low breakaway torque and when abrasive media is used</li> <li>• Additional dust extruder to protect primary seal lip</li> <li>• 適用於轉軸真圓度不佳或偏擺較大的場合</li> <li>• 適用於一般低起步扭矩與有腐蝕性介質的旋轉應用</li> <li>• 可應用於多粉塵環境</li> </ul>

# HiPerLip® - Product Profiles

## 鐵氟龍唇式旋轉密封件(搭配鐵殼)型式

Profile 型式	Operating Condition 運轉條件		
	Press. 壓力	Temp. 溫度	Speed 速度
MD 	≤ 8 bar (125 psi)	- 40 °C to 200 °C (- 40 °F to 392 °F)	≤ 10.2 m/s (2000 fpm)
KD 	≤ 17.25 bar (250 psi)	- 40 °C to 200 °C (- 40 °F to 392 °F)	≤ 10.2 m/s (2000 fpm)
KB 	≤ 5 bar (Each side) (75 psi)	- 40 °C to 200 °C (- 40 °F to 392 °F)	≤ 25.4 m/s (5000 fpm)
SB 	≤ 17.25 bar (Double Lip) (250 psi) ≤ 5 bar (Single Lip) (75 psi)	- 40 °C to 200 °C (- 40 °F to 392 °F)	≤ 25.4 m/s (5000 fpm)
MA 	≤ 5 bar (75 psi)	- 40 °C to 200 °C (- 40 °F to 392 °F)	≤ 25.4 m/s (5000 fpm)
KA 	≤ 17.25 bar (250 psi)	- 40 °C to 200 °C (- 40 °F to 392 °F)	≤ 25.4 m/s (5000 fpm)

For other operating conditions, please contact us.  
如有其他工況需求，歡迎與我們聯絡

<b>Features</b> 特性	<b>Applications</b> 應用
Standard formed primary lip with Spring and Wiper 標準單密封唇型 (加彈簧、防塵)	<ul style="list-style-type: none"> <li>• Suitable for poor roundness or high round-out shaft</li> <li>• Suitable when abrasive media is used</li> <li>• Additional dust extruder to protect primary seal lip</li> <li>• 適用於轉軸真圓度不佳或偏擺較大的場合</li> <li>• 適用於有腐蝕性介質應用</li> <li>• 可應用於多粉塵環境</li> </ul>
Dual formed primary lip with Spring and Wiper 雙密封唇型(加彈簧、防塵)	<ul style="list-style-type: none"> <li>• Suitable for poor roundness or high round-out shaft</li> <li>• Suitable when abrasive media is used</li> <li>• Additional dust extruder to protect primary seal lip</li> <li>• 適用於轉軸真圓度不佳或偏擺較大的場合</li> <li>• 適用於有腐蝕性介質應用</li> <li>• 可應用於多粉塵環境</li> </ul>
Opposite lip arrangement 鏡面對稱配置唇型	<ul style="list-style-type: none"> <li>• Separate two different media on both ends</li> <li>• Suitable for centrifugal application</li> <li>• 可將2種不同的流體隔離</li> <li>• 很適用於離心機設備</li> </ul>
Opposite lip arrangement with dual lips 標準單密封唇型 (加彈簧、防塵)	<ul style="list-style-type: none"> <li>• Separate two different media on both ends</li> <li>• Suitable for centrifugal application</li> <li>• Can perform under higher pressure condition than KB</li> <li>• 可將2種不同的流體隔離</li> <li>• 很適用於離心機設備</li> <li>• 比KB還要能承受更大的壓力</li> </ul>
Standard formed primary lip 標準單密封唇型	<ul style="list-style-type: none"> <li>• General rotary applications</li> <li>• Similar with M1 design, only difference is the direction of the lip</li> <li>• Suitable for food &amp; beverage application</li> <li>• 一般通用旋轉應用</li> <li>• 此型號的設計與M1型相似，唯一不同的是密封唇的方向</li> <li>• 適用於食品級等應用</li> </ul>
Dual formed primary lips 雙密封唇型	<ul style="list-style-type: none"> <li>• Low leakage systems</li> <li>• Similar with K2 design, only difference is the direction of the lip</li> <li>• Suitable for food &amp; beverage application</li> <li>• 可使用於低洩漏系統</li> <li>• 此型號的設計與K2型相似，唯一不同的是密封唇的方向</li> <li>• 適用於食品級等應用</li> </ul>



## HiPerFlon®

### PTFE Rotary Lip Seal with O Ring

#### 鐵氟龍翻唇式旋轉密封件 (搭配O型環)

HiPerFlon® is a rotary lip seal that features an ID lip that seals dynamically on shaft and with O-ring centered on the OD. Similar to the concept of HiPerLip®, it uses formed sealing lips to prevent leakage and is suitable for medium to high speeds in low pressure applications. It is suitable when corrosive media are being sealed in the application. HiPerFlon® is composed of a variety of PTFE compound materials and is often selected for applications where the working environment exceeds the capabilities of traditional elastomer seals, such as high corrosion, high and low temperature, and poor lubrication.

HiPerFlon® is available in a wide variety of PTFE compounds, and utilize common O-ring material choices like fluorocarbon, silicone, nitrile, and EPDM. The use of standard O-ring and PTFE compounds create an easily adaptable solution for all kinds of high-speed applications. The operating temperature range can be from -40°C to 200°C (-40°F to 390°F), and the speed can reach up to 30 m/s (5900 fpm) in low pressure applications. The HiPerFlon® has low friction characteristics which can reduce heat generation and avoid oil carbonization.

Standard HiPerFlon® sizes are precision machined to fit inch-fractional and metric gland geometries, and in-house processing allows custom seal cross sections and diameters to meet any customer request.

HiPerFlon® 是個由內徑密封動態應用的鐵氟龍密封唇與外徑將密封件固定在工件的O型環所組成的旋轉密封件。因與HiPerLip®的設計概念相似，利用非彈簧制動的密封唇來防止洩漏，所以接觸力量會相對的比有彈簧油封還要低，因此適合在高速的應用下運作。由於密封件的主要本體採用鐵氟龍的材質，所以非常適合用在高腐蝕性的環境之下。

HiPerFlon® 是由多種PTFE複合材料和其他可加工的塑膠材料組成的，經常被選用在當工作環境超出傳統彈性體密封件能力的應用，比如高腐蝕、高低溫、不良潤滑等應用。標準O型密封圈選擇包括有碳氟化合物、矽樹脂、腈和三元乙丙橡膠。廣泛地標準O型密封圈以及PTFE鐵氟龍材料的選擇，可以進行客製加工並使用於幾乎所有的應用上。使用溫度範圍可由 -40°C至 200°C (-40°F to 390°F)，在低壓的應用旋轉速度可高達 30 m/s (5900 fpm)，其低摩擦特性可以減少摩擦熱，避免潤滑油脂碳化。

由於HiPerFlon® 是由模製的鐵氟龍管料加工而成，所以設計極為靈活，標準以及非標準的設計經過精密加工可適用於英制和公制溝槽幾何設計。選用標準治具與程式能夠減少前置作業以及編程時間能夠更有效率地製作密封件。



## HiPerFlon® Component

### 鐵氟龍翻唇式旋轉密封件 (搭配O型環)元件

The components of HiPerFlon® may vary between the various designs. Each rotary seal will consist of PTFE sealing element and an O-Ring, and some may require additional spring support.

HiPerFlon® 可以根據不同的工況條件進行客製化的設計。每個旋轉密封件將由鐵氟龍密封元件與O型環所組成，少數的應用可能需要彈簧加力的設計。

#### PTFE Body

- Provides spaces for sealing lips to form curved shape.
- Sizes can be customized based on the groove size.
- Provide space for O Ring

#### PTFE鐵氟龍本體

- 提供密封唇彎曲的空間
- 可依照溝槽調整尺寸
- 提供O型環存放空間

#### O-Ring

- Prevents the seal from rotating with the shaft.
- Material choices like fluorocarbon, silicone, nitrile, and EPDM.

#### O型環

- 防止密封件隨著轉軸轉動
- 可依照工況選擇對應的材質 (碳氟化合物、矽樹脂、腈和三元乙丙橡膠..等)

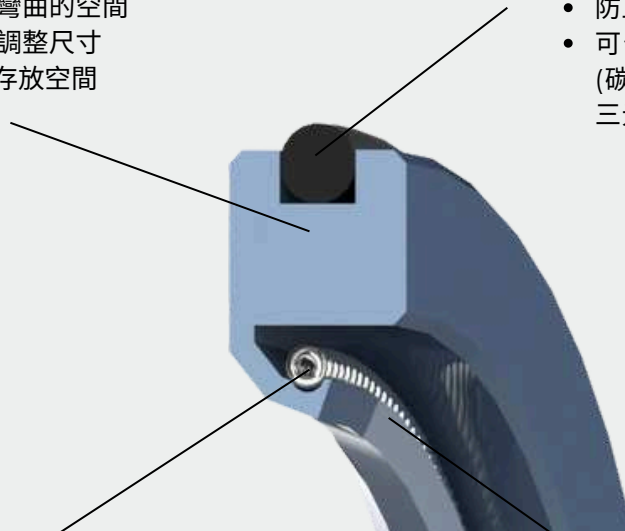

#### Garter Spring

- Provides additional spring load to compensate for shaft runout or shaft misalignment.
- Improves sealing under high speed.

#### 拉伸彈簧

- 在轉軸真圓度不佳或偏擺較大的應用下，提供輔助
- 提高高速下的密封性

#### Sealing lip (element)

- Press directly against the rotating shaft to prevent contaminants and leakage.
- The selection of sealing lip materials will depend on the application.
- Uses PTFE based materials compounded with wear resistant fillers.

#### 密封唇/元件

- 直接緊貼在旋轉的軸上，主要用於防污染物與止漏
- 密封唇的材質會取決於應用工況
- 鐵氟龍材質為主

## Benefits of HiPerFlon®

### 鐵氟龍翻唇式旋轉密封件 (搭配O型環)的優點

#### 1. Medium to high speed and low to medium pressure applications

HiPerFlon® can operate at speeds up to 30 m/s (5900 fpm) with low pressure and a well lubricated environment. The maximum pressure can reach 10 bar (150psi); which is higher than the limit of traditional elastomeric materials.

#### 2. Simple and flexible sealing technique

HiPerFlon® is precision machined to fit both inch-fractional and metric gland geometries which does not require additional tooling. Standard and non-standard sizes are available upon request.

#### 3. Corrosion resistance

The PTFE sealing lip material has excellent resistance to corrosive media (with pH above 4 and below 12.5) even at extreme temperatures and pressures. This limit exceeds the traditional elastomer materials. (The actual corrosion resistance will depend on the material of the O Ring.)

#### 4. Cryogenic and high temp. resistance

Operating in an environment up to 200°C (392°F) or at -40°C (-40°F), HiPerFlon® sealing lips have twice the strength of traditional elastomeric materials and do not struggle from heat-aging or degradation. (The actual temperature resistance limits will depend on the material of the O Ring.)

#### 5. Abrasion resistance

Some traditional elastomeric materials require lubricated oil fillers which could impact negatively on the material properties and reduce sealing life. The HiPerFlon® eliminates this issue and allows it to operate under both dry running and poorly lubricated conditions.

#### 6. Low friction characteristics prevent oil carbonization

HiPerFlon® has very low break-out and dynamic friction even after long down-times. The PTFE compound has a low coefficient of friction (three times lower than elastomers) which reduces heat generated from the interaction with the shaft and prevents oil carbonization.

#### 1. 中至高速與低壓力應用

HiPerFlon® 能夠在低壓力、良好潤滑的環境下以高達30m/s (5900fpm) 的速度運轉。最高壓力範圍可達10 bar (150psi)，遠高於傳統橡膠材料的極限。密封性能與使用壽命遠優於傳統油封。

#### 2. 簡單密封設計

由於HiPerFlon® 的設計簡易、靈活，無須開模具。標準以及非標準的設計經過精密加工可適用於英制和公制溝槽幾何設計。

#### 3. 優異的防腐蝕性

鐵氟龍密封唇材質具有優異的耐化學性，在流體或環境為高腐蝕性會突顯HiPerFlon® 以PTFE鐵氟龍密封材質的優勢。即使在低溫和高溫下對pH值高於4和低於12.5的腐蝕性介質具有出色的耐受性，遠超過傳統油封。(整體的腐蝕性會取決於O型環的材質)

#### 4. 優異的耐高低溫特性

在高達 200°C (392°F) 的環境中，HiPerFlon® 密封唇的強度是傳統彈性材料的兩倍，並且不會因熱老化或變形而失效。即使在 -40°C (-40°F) 的低溫環境下，也不會因低溫產生裂痕的情況。(密封件整體的耐溫性會取決於O型環的材質)

#### 5. 優異的耐磨特性

HiPerFlon® 適用於短期無潤滑或長期潤滑不良的旋轉應用。一些傳統橡膠油封會需要潤滑油填料來解決磨耗問題，但這可能會對材料物性產生負面影響並縮短密封壽命。HiPerFlon® 使用具有自潤滑和低摩擦特性的鐵氟龍材料能夠消除這個問題，讓使用壽命變長。

#### 6. 低摩擦特性防止油碳化

HiPerFlon® 在啟動與運轉的時候，摩擦力極低，即使在長期停機後再度啟用，也能立即擁有低摩擦特性。鐵氟龍鐵氟龍材質具有低摩擦係數(比傳統橡膠低了3倍)，可減少與轉軸之間產生的熱能並防止油碳化。

## HiPerFlon® - Product Profiles

### 鐵氟龍唇式旋轉密封件(搭配O型環)型式

Profile 型式	Operating Condition 運轉條件	Press. 壓力	Temp. 溫度	Speed 速度
NF		≤ 2 bar (30 psi)	- 40 °C to 200 °C (- 40 °F to 392 °F)	≤ 30.5 m/s (6000 fpm)
NA		≤ 4 bar (60 psi)	- 40 °C to 200 °C (- 40 °F to 392 °F)	≤ 25.4 m/s (5000 fpm)
ND		≤ 4 bar (60 psi)	- 40 °C to 200 °C (- 40 °F to 392 °F)	≤ 10.2 m/s (2000 fpm)
NE		≤ 10 bar (150 psi)	- 40 °C to 200 °C (- 40 °F to 392 °F)	≤ 10.2 m/s (2000 fpm)
NK		≤ 4 bar (60 psi)	- 40 °C to 200 °C (- 40 °F to 392 °F)	≤ 25.4 m/s (5000 fpm)
NC		≤ 10 bar (150 psi)	- 40 °C to 200 °C (- 40 °F to 392 °F)	≤ 25.4 m/s (5000 fpm)

\*Actual operating temperature range will depend on O Ring material

\*實際溫度範圍取決於O型環材質

For other operating conditions, please contact us.

如有其他工況需求，歡迎與我們聯絡



<b>Features</b> 特性	<b>Applications</b> 應用
Machined Primary lip 低摩擦密封唇型	<ul style="list-style-type: none"> <li>• Act as a wiper to block out pollutants</li> <li>• Suitable for low friction application</li> <li>• 很適用於軸承保護及防塵用</li> <li>• 適用於低摩擦應用</li> </ul>
Standard Primary lip 標準密封唇型	<ul style="list-style-type: none"> <li>• Standard multipurpose rotary application</li> <li>• Suitable for fans, pumps, compressors, gear-boxes, and engine crank case</li> <li>• 多功能標準旋轉軸密封件</li> <li>• 適用於風車、壓縮機、齒輪箱、引擎曲軸箱等</li> </ul>
Machined Primary lip with Spring 彈簧加強單密封唇型	<ul style="list-style-type: none"> <li>• Suitable for low friction application</li> <li>• Suitable for poor roundness or high round-out shaft</li> <li>• 適用於低摩擦應用</li> <li>• 適用於轉軸真圓度不佳或偏擺較大的旋轉密封</li> </ul>
Dual primary lips with spring 彈簧加強高偏擺型雙密封唇	<ul style="list-style-type: none"> <li>• Suitable for poor roundness or high round-out shaft</li> <li>• Suitable for low to medium pressure application</li> <li>• 適用於轉軸真圓度不佳或偏擺較大的旋轉密封</li> <li>• 適用於低~中壓力應用</li> </ul>
Double acting primary lips 雙向密封唇型	<ul style="list-style-type: none"> <li>• Suitable for fans, pumps, compressors, gear-boxes and engine crank case</li> <li>• Separate two different media on both ends</li> <li>• 適用於風車、壓縮機、齒輪箱、引擎曲軸箱等應用</li> <li>• 可將2種不同的流體隔離</li> </ul>
Dual primary lips 雙密封唇型	<ul style="list-style-type: none"> <li>• Abrasive - resistant and pressure-stable, for use flooded and severe splash application</li> <li>• Suitable for low to medium pressure application</li> <li>• 耐磨且耐壓，適用於嚴重濺灑應用</li> <li>• 適用於低~中壓力應用</li> </ul>

## HiPerFlon® - Product Profiles

### 鐵氟龍唇式旋轉密封件(搭配O型環)型式

Profile 型式	Operating Condition 運轉條件		
	Press. 壓力	Temp. 溫度	Speed 速度
NI 	≤ 4 bar (60 psi)	- 40 °C to 200 °C (- 40 °F to 392 °F)	≤ 25.4 m/s (5000 fpm)
NJ 	≤ 10 bar (150 psi)	- 40 °C to 200 °C (- 40 °F to 392 °F)	≤ 25.4 m/s (5000 fpm)
SA 	≤ 4 bar (60 psi)	- 40 °C to 200 °C (- 40 °F to 392 °F)	≤ 25.4 m/s (5000 fpm)
SC 	≤ 10 bar (150 psi)	- 40 °C to 200 °C (- 40 °F to 392 °F)	≤ 25.4 m/s (5000 fpm)

\*Actual operating temperature range will depend on O Ring material

\*實際溫度範圍取決於O型環材質

For other operating conditions, please contact us.

如有其他工況需求，歡迎與我們聯絡

<b>Features</b> 特性	<b>Applications</b> 應用
Standard Primary lip (with wiper) 單密封唇型 (加防塵)	<ul style="list-style-type: none"> <li>• Standard multipurpose rotary application</li> <li>• Suitable for fans, pumps, compressors, gear-boxes, and engine crank case</li> <li>• Additional dust extruder to protect primary seal lip</li> <li>• 多功能標準旋轉軸密封件</li> <li>• 適用於風車、壓縮機、齒輪箱、引擎曲軸箱等</li> <li>• 可應用於多粉塵環境</li> </ul>
Dual primary lips (with wiper) 雙密封唇型 (加防塵)	<ul style="list-style-type: none"> <li>• Abrasive - resistant and pressure-stable, for use flooded and severe splash application</li> <li>• Suitable for low to medium pressure application</li> <li>• Additional dust extruder to protect primary seal lip</li> <li>• 耐磨且耐壓，適用於嚴重濺灑應用</li> <li>• 適用於低~中壓力應用</li> <li>• 可應用於多粉塵環境</li> </ul>
Formed Primary lip with metal banded 標準密封唇型(加鐵架支撐)	<ul style="list-style-type: none"> <li>• Standard multipurpose rotary application</li> <li>• Suitable for fans, pumps, compressors, gear-boxes, and engine crank case</li> <li>• Suitable for shaft diameter &gt; 100mm</li> <li>• 多功能標準旋轉軸密封件</li> <li>• 適用於風車、壓縮機、齒輪箱、引擎曲軸箱等</li> <li>• 適用於軸徑大於100mm</li> </ul>
Dual primary lips with metal banded 雙密封唇型(加鐵架支撐)	<ul style="list-style-type: none"> <li>• Abrasive - resistant and pressure-stable, for use flooded and severe splash application</li> <li>• Suitable for fans, pumps, compressors, gear-boxes, and engine crank case</li> <li>• Suitable for shaft diameter &gt; 100mm</li> <li>• 耐磨且耐壓，適用於嚴重濺灑應用</li> <li>• 適用於低~中壓力應用</li> <li>• 適用於軸徑大於100mm</li> </ul>



# HiPerSeal®

## Spring Energized Seals

### 鐵氟龍彈簧密封件

HiPerSeal® is a U-shaped machined performance polymer that utilizes a single spring energizer to provide force for the sealing lips. The seal jacket is made from PTFE compounds using high-performance polymer fillers to enhance overall spring seal life and wear resistance properties. The system pressure ultimately increases the sealing force and creates a leak tight seal. Because the spring loaded seal utilizes a spring, slight misalignment is tolerated, and the sealing force and jacket wear is more consistent. Spring energizers are available in corrosion resistant metal alloys such as stainless steel, Elgiloy® and Hastelloy® to meet the most serious corrosive and high temperature applications. We offer a wide variety of springs energizers including Canted Coil springs, Helical springs and Cantilever springs.

The standard spring seal product line is precisely machined to fit AS 568A glands in radial rod and piston grooves and axial face seal configurations. They are suitable for operating under rotary, reciprocating and static applications, as well as the most extreme and harsh conditions. Under rotary applications, they can withstand pressure up to 350 kg/cm<sup>2</sup> (5073psi) and speed up to 3m/s (590 fmp); and temperatures from cryogenic to 225°C (437°F). The spring loaded seal series offers all these capabilities while being able to function in the most chemically aggressive applications. These seals are an extremely effective solution for hydraulic components where low friction and high lateral loads, are combined with corrosive and/or steam environments; all while providing the most consistent friction performance.

HiPerSeal® 是一種U型鐵氟龍內裝特殊彈簧的高性能彈簧密封件，俗稱彈簧油封或彈簧致動油封。鐵氟龍彈簧油封是由適當的彈簧力加上系統流體壓力，將密封唇(面)頂出而輕輕壓住被密封的金屬面以產生優異密封的效果。彈簧的致動效應可以克服金屬配合面的輕微偏心以及密封唇的磨耗，而持續保有預期的密封性能。它能利用各種特殊彈簧來克服鐵氟龍或其他高性能橡膠塑料的彈性問題，開發出可取代絕大多數應用於靜態或動態(往復或旋轉運動)的密封件。而彈簧可因應不同的使用環境，選用不鏽鋼、Elgiloy®、Hastelloy®等，故可應用於各種高溫腐蝕流體的場合。我們提供廣泛的彈簧選擇，其中包含斜圈彈簧(C型彈簧 - Canted Coil Spring)、螺旋彈簧(H型彈簧 - Helical Spring)、懸臂彈簧(V型彈簧 - Cantilever Spring)。

HiPerSeal® 可依AS 568A 標準O型環溝槽(如徑向軸封、活塞密封、軸向的面密封等)製作。此彈簧密封件系列適用於中~重負載之動靜態應用或低速應用，可用應在旋轉、往復與靜態動作之應用。在旋轉應用下，使用溫度範圍可由冷謀至 225°C (437°F)，壓力可達 350kg/cm<sup>2</sup> (5073psi)，轉速可達 3m/s (590 fpm)。此外，它們有助於在高腐蝕的環境應用下，延長密封性能和使用壽命。因其具有密封唇摩擦係數低、密封接觸壓力穩定、耐壓力高、容許較大的徑向偏擺及溝槽尺寸誤差，故非常適用於空油壓缸的密封件。



## HiPerSeal® Component 鐵氟龍彈簧密封件元件

Depending on the working condition the components of HiPerSeal® may vary between the various designs. Each Spring Energized Seal will consist of PTFE sealing jacket and a spring energizer. Some may require an additional O Ring for support.

HiPerSeal®可以根據不同的工況條件進行客製化的設計。每個彈簧密封件將由一個鐵氟龍密封套與彈簧組成，少數的應用可能需要O型環輔助的設計。

### PTFE Seal Jacket

- Main sealing component that prevent contaminants and leakage.
- The material selection and fillers will depend on the application.
- Sizes can be customized based on the groove size.

### PTFE鐵氟龍密封套

- 主要防止污染和洩漏的密封元件
- 材料和填料將取決於應用工況
- 尺寸可依照溝槽尺寸客製

### O-Ring

- Prevents the seal from rotating with the shaft.
- Material choices like fluorocarbon, silicone, nitrile, and EPDM.

### O型環

- 防止密封件隨著轉軸轉動
- 可依照工況選擇對應的材質 (碳氟化合物、矽樹脂、腈和三元乙丙橡膠..等)

### Spring Energizer

- Provide a consistent and controlled sealing force between the sealing surfaces.
- Helps to prevent extrusion
- The spring type and material will depend on the application.

### 彈簧

- 提供密封件穩定且受控的力量
- 有助於防止密封件擠出問題
- 彈簧類型和材料會取決於工作條件

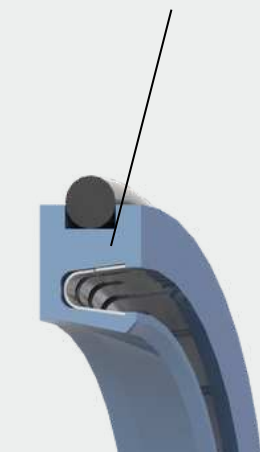

**Cantilever Spring**  
懸臂彈簧  
(V型彈簧)



**Canted Coil Spring**  
斜圈彈簧  
(C型彈簧)

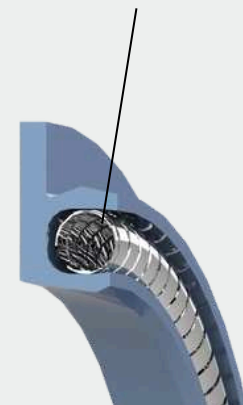

**Helical Spring**  
螺旋彈簧  
(H型彈簧)

## Benefits of HiPerSeal®

### 鐵氟龍彈簧密封件的優點

#### 1. Suitable for high pressure applications.

HiPerSeal® can withstand up to 350 bar (5076psi) under rotary dynamics. It performs best with well lubricated environments, but it is also capable of sealing in dry applications. It exceeds the capabilities of traditional elastomeric seals.

#### 2. Simple and flexible sealing technique

HiPerSeal® seal jacket is precision machined to fit both inch-fractional and metric gland geometries which does not require additional tooling. The springs can also be customized into different dimensions, providing a great flexibility in customizations.

#### 3. Corrosion resistance

The PTFE material has excellent resistance to corrosive media (with pH above 4 and below 12.5) even at extreme temp. and pressures. The spring can also be made from erosion resistant material such as high nickel alloys (Hastelloy®) or Elgiloy®.

#### 4. Cryogenic and high temp. resistance

HiPerSeal® can operate in an environment up to 225°C (437°F) and can withstand cryogenic environment. With PTFE material and fillers, the seal jacket can easily be adjusted to according to the operating conditions.

#### 5. Abrasion resistance

Some traditional elastomeric materials require lubricated oil fillers which could impact negatively on the material properties and reduce sealing life. The HiPerSeal® eliminates this issue and allows it to operate under both dry running and poorly lubricated conditions.

#### 6. Low friction characteristics prevent oil carbonization

HiPerSeal® has very low break-out and dynamic friction even after long down-times. The PTFE compound has a low coefficient of friction (three times lower than elastomers) which reduces heat generated from the interaction with the shaft and prevents oil carbonization.

#### 1. 適用於高壓應用

HiPerSeal® 能夠在旋轉的作動下承受高達350 bar (5076psi)的壓力。在良好潤滑的環境下可達成最佳的密封性能，但在無潤滑的環境下，也可以達成優良的止漏效果，遠高於傳統橡膠材料的極限，密封性能與使用壽命也遠優於傳統油封。

#### 2. 靈活密封設計

由於HiPerSeal® 由專業CNC車床生產，製作靈活，無須開模具。密封件溝槽內可填充任何抗汙染材料(如矽膠)，彈簧也可依照實際需求尺寸進行客製化，標準以及非標準的設計經過精密加工可適用於英制和公制溝槽幾何設計。

#### 3. 優異的防腐蝕性

鐵氟龍密封唇材質具有優異的耐化學性，即使在低溫和高溫下對pH值高於4和低於12.5的腐蝕性介質具有出色的耐受性。彈簧也可以搭配耐腐蝕材料，例如高鎳合金 (Hastelloy®)、Elgiloy®，以提高整體密封件的耐腐蝕性。

#### 4. 優異的耐高低溫特性

HiPerSeal® 可在高達 225°C (437°F) 的環境中運作，使密封件不會因熱老化或變形而失效。即使在極低溫環境下，也不會產生裂痕的情況。鐵氟龍與添料可依照工況進行設計與挑選。

#### 5. 優異的耐磨性

HiPerSeal® 適用於短期無潤滑或長期潤滑不良的旋轉應用。一些傳統橡膠油封會需要潤滑油填料來解決磨耗問題，但這可能會對材料物性產生負面影響並縮短密封壽命。HiPerSeal® 使用具有自潤滑和低摩擦特性的鐵氟龍材料能夠消除這個問題，讓使用壽命變長。

#### 6. 低摩擦特性防止油碳化

HiPerSeal® 在啟動與運轉的時候，摩擦力極低，即使在長期停機後再度啟用，也能立即擁有低摩擦特性，不受啟動時潤滑不足的影響。鐵氟龍材質具有低摩擦係數(比傳統橡膠低了3倍)，可減少與轉軸之間產生的熱能並防止油碳化。

# HiPerSeal® - Product Profiles

## 鐵氟龍彈簧密封件型式

### Flange Series

#### 法蘭式設計

HiPerSeal®'s Flange series has a set of standard groove dimension. It can be fit with AS 568A (or other standard O - Ring Groove, DIN 3771, ISO 3601 etc. ) without any hardware modification.

HiPerSeal®的法蘭式設計擁有一套標準的尺寸指南，適用於標準的O型環密封件溝槽，能輕易地取代O型環而安裝於符合AS 568, DIN 3771, ISO 3601 等標準溝槽。

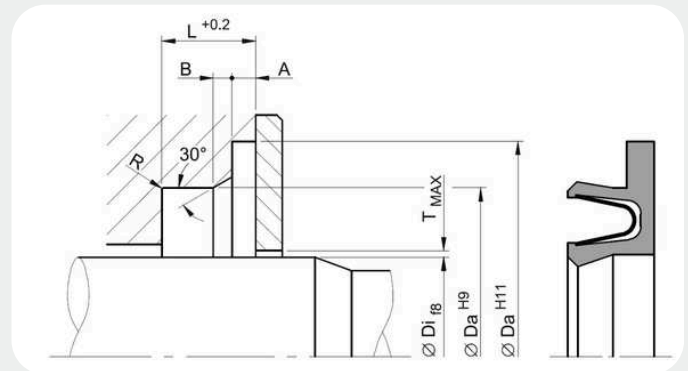



Profile 型式	Operating Condition 運轉條件		
	Pressure 壓力	Temperature 溫度	Speed 速度
VD	≤ 350 bar (5076 psi)	-150 °C to 200 °C (- 238 °F to 392 °F)	≤ 3 m/s (590 fpm)
VDW	≤ 350 bar (5076 psi)	-150 °C to 200 °C (- 238 °F to 392 °F)	≤ 3 m/s (590 fpm)
CD	≤ 350 bar (5076 psi)	-150 °C to 200 °C (- 238 °F to 392 °F)	≤ 3 m/s (590 fpm)
CDTW	≤ 350 bar (5076 psi)	-150 °C to 200 °C (- 238 °F to 392 °F)	≤ 3 m/s (590 fpm)
HD	≤ 450 bar (6526 psi)	-150 °C to 200 °C (- 238 °F to 392 °F)	≤ 1 m/s (196 fpm)

For other operating conditions, please contact us.  
如有其他工況需求，歡迎與我們聯絡

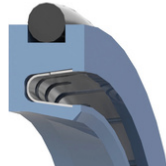
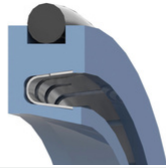
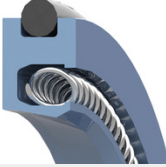

桿徑 Rod Diameter	溝槽底徑 Groove Bottom	溝槽寬度 Groove Width	凸緣直徑 Flange dia.	凸緣深度 Flange depth	倒角長度 Chamfer Length	間隙 Gap	圓角 Radius	O型環代碼 O-Ring Code
Ø Di	Ø Da	L	Ø Df	A	B	T	R	
8 ~ 19.9	Di + 5.0	3.6	Di + 9.0	0.85	0.8	0.06	0.3	B
20 ~ 39.9	Di + 7.0	4.8	Di + 12.5	1.35	1.1	0.07	0.4	C
40 ~ 400.9	Di + 10.5	7.1	Di + 17.5	1.80	1.4	0.08	0.5	D
401 ~ 700.0	Di + 14.0	9.5	Di + 22.0	2.80	1.6	0.12	0.5	E

Features 特性	Applications 應用
Flanged heel with Cantilever Spring 法蘭式設計搭配V型彈簧	<ul style="list-style-type: none"> <li>• General rotary applications</li> <li>• Very good sealability under low pressure</li> <li>• 一般旋轉通用應用</li> <li>• 低壓下有非常良好的密封效果</li> </ul>
Flanged heel with Cantilever Spring and Wiper 法蘭式設計搭配V型彈簧與刮塵	<ul style="list-style-type: none"> <li>• Similar application with VD but with scraper on ID to minimizes contamination threat</li> <li>• 與 VD 類似的應用，但內徑上有刮刀設計，以減少污染威脅</li> </ul>
Flanged heel with Canted Coil Spring 法蘭式設計搭配C型彈簧	<ul style="list-style-type: none"> <li>• General rotary applications</li> <li>• Provides better torque control for low friction application</li> <li>• Good sealability under low pressure</li> <li>• 一般旋轉通用應用</li> <li>• 為低摩擦應用提供更好的扭力控制</li> <li>• 低壓下有良好的密封效果</li> </ul>
Flanged heel with Canted Coil Spring and Wiper 法蘭式設計搭配C型彈簧與刮塵	<ul style="list-style-type: none"> <li>• Similar application with CD but with scraper on ID to minimizes contamination threat</li> <li>• 與 CD 類似的應用，但內徑上有刮刀設計，以最大限度地減少污染威脅</li> </ul>
Flanged heel with Helical Spring 法蘭式設計搭配H型彈簧	<ul style="list-style-type: none"> <li>• Static or intermittent rotary only</li> <li>• High sealability and friction</li> <li>• Excellent sealability under low pressure</li> <li>• 適用於間接旋轉或靜態應用</li> <li>• 高密封性和摩擦力</li> <li>• 對於低壓有非常出色的密封效果</li> </ul>

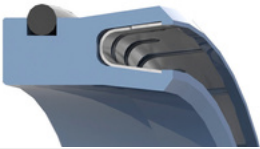
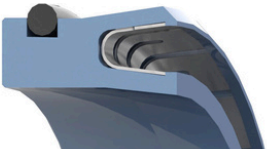
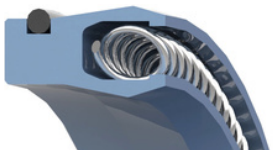
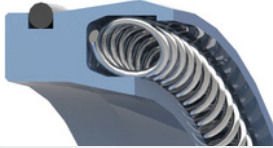
Profile 型式	Operating Condition 運轉條件		
	Pressure 壓力	Temperature* 溫度*	Speed 速度
VH 	≤ 350 bar (5076 psi)	- 40 °C to 200 °C (- 40 °F to 392 °F)	≤ 3 m/s (590 fpm)
VHW 	≤ 350 bar (5076 psi)	- 40 °C to 200 °C (- 40 °F to 392 °F)	≤ 3 m/s (590 fpm)
CH 	≤ 350 bar (5076 psi)	- 40 °C to 200 °C (- 40 °F to 392 °F)	≤ 3 m/s (590 fpm)
CHTW 	≤ 350 bar (5076 psi)	- 40 °C to 200 °C (- 40 °F to 392 °F)	≤ 3 m/s (590 fpm)
VL 	≤ 350 bar (5076 psi)	- 40 °C to 200 °C (- 40 °F to 392 °F)	≤ 3 m/s (590 fpm)
VLW 	≤ 350 bar (5076 psi)	- 40 °C to 200 °C (- 40 °F to 392 °F)	≤ 3 m/s (590 fpm)
CL 	≤ 350 bar (5076 psi)	- 40 °C to 200 °C (- 40 °F to 392 °F)	≤ 3 m/s (590 fpm)
CLTW 	≤ 350 bar (5076 psi)	- 40 °C to 200 °C (- 40 °F to 392 °F)	≤ 3 m/s (590 fpm)

\*Actual operating temperature range will depend on O Ring material

\*實際溫度範圍取決於O型環材質

<b>Features</b> 特性	<b>Application</b> 應用
O Ring centered in OD with Cantilever Spring 外徑中心O型環搭配V型彈簧	<ul style="list-style-type: none"> <li>• Suitable for Medium load and low speed conditions</li> <li>• Commonly used in pumps and motors</li> <li>• 適合用於中負載之低速應用</li> <li>• 常用於泵浦、電機</li> </ul>
O Ring centered in OD with Cantilever Spring and Wiper 外徑中心O型環搭配V型彈簧與刮塵	<ul style="list-style-type: none"> <li>• Similar application with VH but with scraper on ID to minimizes contamination threat</li> <li>• 與 VH 類似的應用，但內徑上有刮刀設計，以最大限度地減少污染威脅</li> </ul>
O Ring centered in OD with Canted Coil Spring 外徑中心O型環搭配C型彈簧	<ul style="list-style-type: none"> <li>• Suitable for Medium load and low speed conditions</li> <li>• Suitable for applications require close control of friction or torque</li> <li>• Suitable for wider hardware tolerances</li> <li>• 適合用於中負載之低速應用</li> <li>• 適合需要嚴密控制摩擦或扭矩之應用</li> <li>• 適用於較大的硬件公差</li> </ul>
O Ring centered in OD with Canted Coil Spring and Wiper 外徑中心O型環搭配C型彈簧與刮塵	<ul style="list-style-type: none"> <li>• Similar application with CH but with scraper on ID to minimizes contamination threat</li> <li>• 與 CH類似的應用，但內徑上有刮刀設計，以最大限度地減少污染威脅</li> </ul>
O Ring heel in OD with Cantilever Spring 外徑O型環搭配V型彈簧	<ul style="list-style-type: none"> <li>• Suitable for Medium load and low speed conditions</li> <li>• Common used in pumps and motors</li> <li>• 適合用於中負載之低速應用</li> <li>• 常用於泵浦、電機</li> </ul>
O Ring heel in OD with Cantilever Spring and Wiper 外徑O型環搭配V型彈簧與刮塵	<ul style="list-style-type: none"> <li>• Similar application with VL but with scraper on ID to minimizes contamination threat</li> <li>• 與 VL 類似的應用，但內徑上有刮刀設計，以最大限度地減少污染威脅</li> </ul>
O Ring heel in OD with Canted Coil Spring 外徑O型環搭配C型彈簧	<ul style="list-style-type: none"> <li>• Suitable for Medium load and low speed conditions</li> <li>• Suitable for applications require close control of friction or torque</li> <li>• Suitable for wider hardware tolerances</li> <li>• 適合用於中負載之低速應用</li> <li>• 適合需要嚴密控制摩擦或扭矩之應用</li> <li>• 適用於較大的硬件公差</li> </ul>
O Ring heel in OD with Canted Coil Spring and Wiper 外徑O型環搭配C型彈簧與刮塵	<ul style="list-style-type: none"> <li>• Similar application with CL but with scraper on ID to minimizes contamination threat</li> <li>• 與 CL類似的應用，但內徑上有刮刀設計，以最大限度地減少污染威脅</li> </ul>



## PTFE Rotary Glide Seal Set

### 鐵氟龍液壓旋轉密封件

PTFE Rotary Glide seal sets consists of a PTFE sealing element with a rubber O-ring functioning as elastic energizer. This type of Teflon seal is mainly used to seal reciprocating rods, pistons, and plungers, commonly found in hydraulic and pneumatic applications. The required sealing effect is achieved by radial pressure, produced by the preloaded element and system pressure, on the lip against mating surface. The elastic energizer pushes the PTFE ring against the mating surface which provides the initial sealing force for the PTFE seal.

PTFE Rotary Glide seal sets can provide much lower friction without any stick-slip effect to guarantee smooth running even for intermittent operation or long-stroke application. They perform reliable sealing even under high service pressures and surface speeds. The inherent low friction and wear resistant properties of our PTFE compounds will effectively improve the service life of the seals and help reduce maintenance costs. PTFE Rotary Glide Seal Sets are also preferred for applications with difficult operating conditions such as construction equipment, chemical processing, off-shore, galvanizing and color coating lines, and coal-fired power plants where dusty, high temperature, aggressive media, or intermittent motion are quite common. They are also widely used in food, medical and semiconductor processing equipment as well.

Various seal profiles can fit most single and double acting cylinders. Some compact profiles have been well developed to fit AS 568A standard O-ring grooves for one or two back-up rings.

鐵氟龍液壓密封件是由一個由鐵氟龍密封元素和橡膠O型環組成的密封元件。PTFE油封受到背後O型環的彈力致動，使唇尖輕壓接觸軸或活塞表面而發揮作用。鐵氟龍密封件依應用的條件而有各種形式，如單動與雙動的密封唇設計便有明顯的不同，目前亦有針對適用於標準O型環溝槽而開發的鐵氟龍導引密封件。這種鐵氟龍油封主要用於密封往復運動桿、活塞和柱塞，通常用於液壓和氣動應用。

鐵氟龍液壓油封可以提供低摩擦力，即使在間歇操作或長行程應用中也能保證平穩運行。即使在高工作壓力和/或高表面速度下，以鐵氟龍為原料的PTFE密封件也能執行可靠的密封功能。PTFE具有固有的低摩擦和耐磨性能，可有效提高密封件在往復運動應用中的使用壽命，並有助於降低維護成本。由於製程設備日益複雜精密，空油壓缸早已脫離過去單純的負載提供者，如何精確地定位、即時而平順地作動，已成為普遍性的需求，鐵氟龍油封可以大幅改善傳統的橡膠密封件的高滑動摩擦係數及滯滑效應。另外，對於環境較嚴苛的應用(如高粉塵、高溫、化學品，油田(井)、間歇作動等)，如建設機械、化學製程、鋼品鍍面烤漆、燃煤電廠鍋爐、高溫窯爐等，亦可以有效且長期地保持密封性能，因而避免重要設備故障或產線停機的重大損失。鐵氟龍的潔淨無污染本質，使得鐵氟龍液壓密封件也廣受食品、製藥、半導體等相關製程的歡迎。



## PTFE Rotary Glide Ring Set - Type TR 鐵氟龍液壓旋轉密封件 - TR 型式

TR rotary seal is designed for internal sealing in bi-directional pressurization applications.  
TR型旋轉密封設計適用於雙向壓力動氣壓缸的活塞密封應用

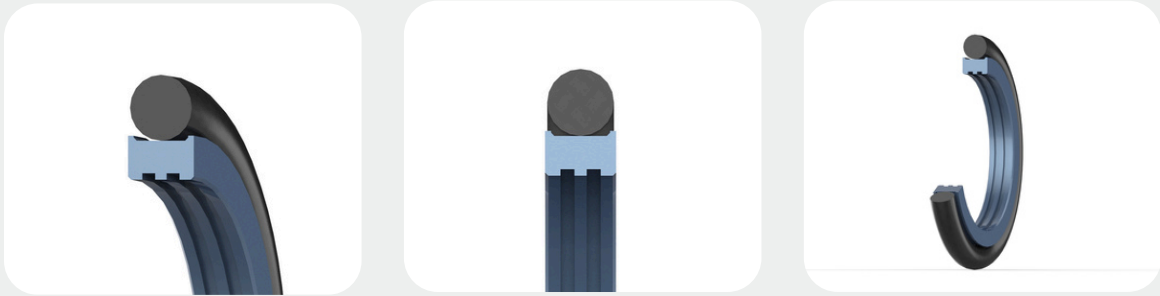

- Common application: rotating track bushings, swivel joints, hose reels, and in machine tool hydraulics
- A wiper ring near opening is recommended if TR seal is used as an end seal.
- High extrusion and high temperature resistance
- 典型應用包括: 循跡回轉襯套、迴旋接頭、軟管捲軸(筒)、及工作母機的油壓系統
- 作為末端密封件時, 建議在開口處加裝刮塵件
- 高抗擠壓與高溫特性

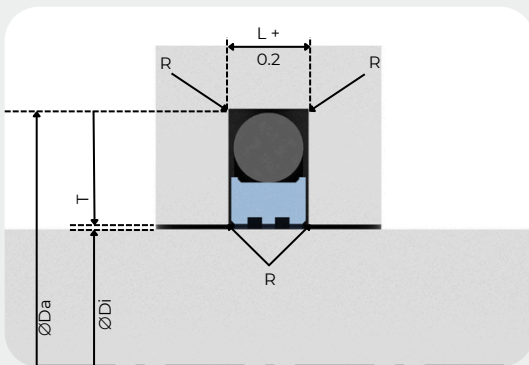

### Application Range:

#### 應用範圍:

壓力 Pressure:  $\leq 350$  bar (4350 psi)

溫度 Temperature:  $-40$  °C to  $200$  °C ( $-40$  °F to  $392$  °F)

速度 Speed:  $\leq 1$  m/s (196 fpm)

**\*Standard Material: Carbon fiber filled PTFE**

**\*標準材質: 碳纖填料鐵氟龍**

單位 Unit: mm

Rod diameter 桿徑	Groove Bottom 溝槽底徑	Groove Width 溝槽寬度	Radius 溝槽R角	Gap 擠出間隙	Gland Code 截面	O Ring C.S. O形環
$\varnothing Di$	$\varnothing Da$	L	R	T		
5 ~ 7.9	$Di + 4.9$	2.2	0.5	0.1	A	1.78
8 ~ 18.9	$Di + 7.5$	3.2	0.5	0.1	B	2.62
19 ~ 37.9	$Di + 11.0$	4.2	0.5	0.15	C	3.53
38 ~ 199.9	$Di + 15.5$	6.3	0.9	0.2	D	5.33
200 ~ 255.9	$Di + 21.0$	8.1	0.9	0.25	E	6.99
256 ~ 650.0	$Di + 24.5$	8.1	0.9	0.25	F	6.99

## PTFE Rotary Glide Ring Set - Type TP

### 鐵氟龍液壓旋轉密封件 - TP 型式

TP rotary seal is designed for external sealing in bi-directional pressurization applications  
 TP型旋轉密封設計適用於雙動氣壓缸的活塞密封



- Common application: rotating track bushings, swivel joints, hose reels, and in machine tool hydraulics
- Similar to profile TR but suitable for external pressure applications
- High extrusion and high temperature resistance
- 典型應用包括: 循跡回轉襯套、迴旋接頭、軟管捲軸(筒)、及工作母機的油壓系統
- 與TR 型旋轉軸密封件的應用相似, 但適用外壓場合
- 高抗擠壓與高溫特性

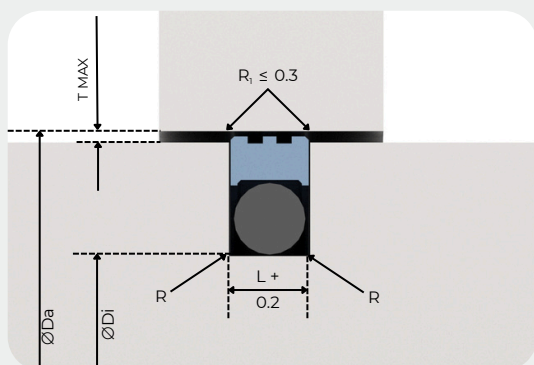

#### Application Range:

##### 應用範圍:

壓力 Pressure:  $\leq 350$  bar (4350 psi)

溫度 Temperature:  $-40$  °C to  $200$  °C ( $-40$  °F to  $392$  °F)

速度 Speed:  $\leq 1$  m/s (196 fpm)

**\*Standard Material: Carbon fiber filled PTFE**

**\*標準材質: 碳纖填料鐵氟龍**

單位 Unit: mm

Cylinder Bore 缸徑	Groove Bottom 溝槽底徑	Groove Width 溝槽寬度	Radius 溝槽R角	Gap 擠出間隙	Gland Code 截面	O Ring C.S. O形環
$\varnothing Da$	$\varnothing Di$	L	R	T		
8 ~ 14.9	Da - 4.9	2.2	0.5	0.1	A	1.78
15 ~ 39.9	Da - 7.5	3.2	0.5	0.1	B	2.62
40 ~ 79.9	Da - 11.0	4.2	0.5	0.15	C	3.53
80 ~ 132.9	Da - 15.5	6.3	0.9	0.2	D	5.33
133 ~ 329.9	Da - 21.0	8.1	0.9	0.25	E	6.99
330 ~ 650.0	Da - 24.5	8.1	0.9	0.25	F	6.99

# Material Selection

## PTFE Compound

Ref.	Compound	Color	Temp. (MIN.)	Temp. (MAX.)	Application	Characteristics
03T	<b>Carbon Filled PTFE</b>	Black	- 200 °C (- 328 °F)	200 °C (- 392 °F)	<ul style="list-style-type: none"> <li>High Mechanical Stress</li> <li>Rotary Sealing</li> <li>Water/Oil Hydraulics</li> </ul>	<ul style="list-style-type: none"> <li>High Wear Resistance</li> <li>Creep Resistance</li> </ul>
05T	<b>Carbon Fiber Filled PTFE</b>	Black	- 200 °C (- 328 °F)	200 °C (- 392 °F)	<ul style="list-style-type: none"> <li>Aqueous Environment</li> </ul>	<ul style="list-style-type: none"> <li>Excellent Wear Resistance Properties In Water</li> <li>Dynamic Applications At High Speed</li> <li>Excellent Compressive Strengths</li> </ul>
07T	<b>EKONOL Filled PTFE</b>	Beige	- 200 °C (- 328 °F)	200 °C (- 392 °F)	<ul style="list-style-type: none"> <li>Medium Mechanical Stress</li> <li>Softer Sealing Surfaces</li> </ul>	<ul style="list-style-type: none"> <li>Limited Chemical Resistance</li> <li>Limited Use In Hot Water</li> </ul>
09T	<b>Graphite Filled PTFE</b>	Black	- 200 °C (- 328 °F)	200 °C (- 392 °F)	<ul style="list-style-type: none"> <li>Low Mechanical Stress</li> <li>Soft Sealing Surfaces</li> </ul>	<ul style="list-style-type: none"> <li>Chemical Resistance Limited By Graphite</li> </ul>
19T	<b>Glass Fiber &amp; MOS2 Filled PTFE</b>	Grey	- 200 °C (- 328 °F)	200 °C (- 392 °F)	<ul style="list-style-type: none"> <li>High Speed Rotary Applications</li> <li>High Pressure Rotary Applications</li> </ul>	<ul style="list-style-type: none"> <li>High Creep Strength</li> <li>High Chemical Resistance</li> <li>Outstanding Wear Resistance</li> <li>Excellent extrusion resistance for high pressure application</li> </ul>
33T	<b>Glass Fiber Filled PTFE</b>	Yellow	- 200 °C (- 328 °F)	200 °C (- 392 °F)	<ul style="list-style-type: none"> <li>Air Compressor</li> </ul>	<ul style="list-style-type: none"> <li>High Chemical Resistance</li> <li>Electrical Properties Like Virgin PTFE</li> <li>High Creep Resistance</li> </ul>
01R	<b>PEEK Filled PTFE (FDA)</b>	Brown	- 240 °C (- 400 °F)	288 °C (500 °F)	<ul style="list-style-type: none"> <li>Food &amp; Beverage Application</li> </ul>	<ul style="list-style-type: none"> <li>Excellent Physical Properties</li> <li>Good Chemical Resistance</li> <li>Compatible with most commercial natural lubricants</li> </ul>
02R	<b>Calcium Silicate Filled PTFE (FDA)</b>	White	- 240 °C (- 400 °F)	288 °C (500 °F)	<ul style="list-style-type: none"> <li>Food &amp; Beverage Application</li> <li>Pharmaceutical Industry</li> </ul>	<ul style="list-style-type: none"> <li>Excellent Performance under Non-Lubricated Environment</li> </ul>
03R	<b>PI Filled PTFE</b>	Yellow	- 240 °C (- 400 °F)	288 °C (500 °F)	<ul style="list-style-type: none"> <li>Softer Sealing Surfaces</li> </ul>	<ul style="list-style-type: none"> <li>Lowest Coefficient of friction</li> <li>Excellent Physical Properties</li> <li>Excellent performance against soft mating surfaces</li> </ul>

\*Other material available upon request

\*Applications are for references, not limited to



## 材料選項

### 鐵氟龍填料

材質編號	填充料	顏色	最低溫度	最高溫度	應用範圍	特色
03T	碳 + 石墨 + 鐵氟龍	黑色	- 200 °C (- 328 °F)	200 °C (- 392 °F)	<ul style="list-style-type: none"> <li>高機械應力應用</li> <li>水/ 油壓機械</li> <li>旋轉密封應用</li> </ul>	<ul style="list-style-type: none"> <li>優越的耐磨性</li> <li>抗潛變性佳</li> </ul>
05T	碳纖維 + 鐵氟龍	黑色	- 200 °C (- 328 °F)	200 °C (- 392 °F)	<ul style="list-style-type: none"> <li>水壓機械</li> </ul>	<ul style="list-style-type: none"> <li>在水中應用下擁有優越的耐磨性</li> <li>優越的抗壓強度</li> <li>適用於高速動態應用</li> </ul>
07T	EKONOL + 鐵氟龍	米色	- 200 °C (- 328 °F)	200 °C (- 392 °F)	<ul style="list-style-type: none"> <li>中等機械應力應用</li> <li>用於軟質的軸面</li> <li>旋轉密封應用</li> </ul>	<ul style="list-style-type: none"> <li>抗化學性有限</li> <li>不適用於高 水中</li> </ul>
09T	石墨 + 鐵氟龍	黑色	- 200 °C (- 328 °F)	200 °C (- 392 °F)	<ul style="list-style-type: none"> <li>低機械應力應用</li> <li>用於軟質軸面</li> </ul>	<ul style="list-style-type: none"> <li>受限於石墨成分，抗化學性有限</li> </ul>
19T	玻璃纖維 + 二硫化鉬 + 鐵氟龍	灰色	- 200 °C (- 328 °F)	200 °C (- 392 °F)	<ul style="list-style-type: none"> <li>高速旋轉應用</li> <li>高壓旋轉應用</li> </ul>	<ul style="list-style-type: none"> <li>抗潛變性佳</li> <li>優越的耐化學性質</li> <li>出色的耐磨性</li> <li>優異的抗擠壓性能</li> </ul>
33T	玻璃纖維 + 鐵氟龍	黃色	- 200 °C (- 328 °F)	200 °C (- 392 °F)	<ul style="list-style-type: none"> <li>空壓機</li> </ul>	<ul style="list-style-type: none"> <li>優越的抗化學性</li> <li>抗潛變性佳</li> <li>低介電常數</li> </ul>
01R	PEEK + 鐵氟龍 (FDA)	棕色	- 240 °C (- 400 °F)	288 °C (500 °F)	<ul style="list-style-type: none"> <li>食品應用</li> </ul>	<ul style="list-style-type: none"> <li>優異的物理性能</li> <li>良好的耐化學性</li> <li>與大多數商用天然潤滑劑相容</li> </ul>
02R	矽酸鈣 + 鐵氟龍 (FDA)	白色	- 240 °C (- 400 °F)	288 °C (500 °F)	<ul style="list-style-type: none"> <li>食品應用</li> <li>製藥業</li> </ul>	<ul style="list-style-type: none"> <li>無潤滑環境下有優異的性能</li> </ul>
03R	PI + 鐵氟龍	黃色	- 240 °C (- 400 °F)	288 °C (500 °F)	<ul style="list-style-type: none"> <li>用於軟質軸面</li> </ul>	<ul style="list-style-type: none"> <li>最低摩擦係數</li> <li>優異的物理性能</li> <li>針對柔軟的配合表面具有出色的性能</li> </ul>

\*若有其他材料的需求，歡迎與我們聯絡

\*應用不限於，僅供參考

## Metal Casing

### 鋼殼材料

Code	Material 材料	Application 應用
1	SS41 Carbon steel SS41 碳鋼	<ul style="list-style-type: none"> <li>Standard material for metal case</li> <li>General application without corrosion issue</li> <li>標準材質</li> <li>一般環境下之滑油或滑脂潤滑之應用</li> </ul>
2	Stainless steel 304 SUS 304 不鏽鋼	<ul style="list-style-type: none"> <li>General application under corrosive environment</li> <li>腐蝕環境下之滑油或滑脂潤滑之應用</li> </ul>
3	Stainless steel 316 SUS 316 不鏽鋼	<ul style="list-style-type: none"> <li>General application for corrosive media</li> <li>腐蝕性流體之密封</li> </ul>

## Gasket

### 靜止密封墊片

Code	Material	Temperature	Application
1	NBR	- 40 °C ~ 100 °C (- 104 °F ~ 212 °F)	<ul style="list-style-type: none"> <li>Standard material for metal case</li> <li>General application without corrosion issue</li> <li>標準材質</li> <li>一般環境下之滑油或滑脂潤滑之應用</li> </ul>
2	FPM (Viton®)	- 20 °C ~ 200 °C (- 104 °F ~ 392 °F)	<ul style="list-style-type: none"> <li>High temperature application without corrosion issue</li> <li>Chemical and heat resistant material</li> <li>高溫下之滑油或滑脂潤滑之應用</li> </ul>

## O Ring

## O 型環

O - Ring Code O型環編號	Compound 材質	Parjet Compound 物料編號	Hardness 硬度 (Shore A)	Temperature range 耐溫
1	NBR	N100A-70	70±5	- 40 °C ~ 100 °C (- 104 °F ~ 212 °F)
2	FPM (Viton®)	V100A-75	75±5	- 25 °C ~ 250 °C (- 13 °F ~ 482 °F)
3	NBR	N100A-90	90±5	- 30 °C ~ 100 °C (- 22 °F ~ 212 °F)
4	FPM (Viton®)	V100A-90	90±5	- 25 °C ~ 250 °C (- 13 °F ~ 482 °F)
5	NBR	N100A-80	80±5	- 30 °C ~ 100 °C (- 22 °F ~ 212 °F)
6	NBR	N134A-70	70±5	- 40 °C ~ 100 °C (- 104 °F ~ 212 °F)
7	EPDM	E100A-70	70±5	- 40 °C ~ 100 °C (- 104 °F ~ 212 °F)
8	Silicone	S100A-70	70±5	- 55 °C ~ 210 °C (- 67 °F ~ 410 °F)
9	HPU	P100A-93	93±5	- 40 °C ~ 110 °C (- 40 °F ~ 230 °F)

## Springs

### 彈簧材質

Material 材質	Cantilever Spring 懸臂彈簧	Canted Coil Spring 斜圈彈簧	Helical Spring 螺旋彈簧
301 Stainless Steel 不鏽鋼	Standard 標準	X	Standard 標準
Hastelloy C276	○	○	○
17-7 PH Stainless Steel 不鏽鋼	X	X	○
Elgiloy or equivalent 或同等材料	○	○	○
302 Stainless Steel 不鏽鋼	X	Standard 標準	X
316 Stainless Steel 不鏽鋼	○	○	○

**Non Standard material available upon request.**  
如需其他材質，歡迎與我們連絡。

# HiPerFlon<sup>®</sup>, HiPerLip<sup>®</sup>, HiPerSeal<sup>®</sup>

## Standard Sizes

### 標準尺寸

**SD** | Shaft diameter  
軸徑

**OD** | Outside diameter  
外徑

**CW** | Casing Width  
寬度

SD	OD	CW	SD	OD	CW	SD	OD	CW	SD	OD	CW	SD	OD	CW	SD	OD	CW
8	22	7	17	32	7	26	47	7	17	28	7	16	35	7	85	120	12
8	24	7	17	35	7	26	40	7	17	28	7	42	72	8	90	110	10
8	26	7	17	40	7	8	22	7	17	32	7	45	60	8	90	120	12
9	22	7	17	30	7	8	24	7	28	47	7	45	62	8	90	110	10
9	24	7	18	32	7	8	26	7	28	52	7	45	65	8	90	120	12
10	22	7	18	35	7	9	22	7	30	40	7	48	65	8	95	120	12
10	24	7	18	40	7	9	24	7	30	42	7	50	68	8	100	120	12
10	26	7	20	30	7	10	22	7	30	45	7	50	72	8	100	125	12
12	22	7	20	32	7	10	24	7	30	47	7	52	72	8	100	130	12
12	24	7	20	35	7	10	26	7	30	50	7	55	72	8	105	130	12
12	26	7	20	40	7	12	22	7	30	52	7	60	75	8	110	130	12
12	28	7	20	47	7	12	24	7	32	45	8	60	80	8	110	140	12
12	30	7	22	32	7	12	26	7	32	47	8	60	85	8	115	140	12
14	24	7	22	35	7	12	28	7	32	52	8	62	80	8	115	150	12
14	28	7	22	40	7	12	30	7	35	47	8	65	85	8	95	120	12
14	30	7	22	47	7	14	24	7	35	50	8	65	90	10	100	120	12
14	35	7	24	35	7	14	28	7	35	52	8	65	100	10	100	125	12
15	26	7	24	37	7	14	30	7	35	55	8	68	90	10	100	130	12
15	30	7	24	40	7	14	35	7	35	62	8	68	100	10	105	130	12
15	32	7	24	47	7	15	26	7	38	55	8	70	90	10	110	130	12
15	35	7	25	35	7	15	30	7	40	52	8	70	95	10	110	140	12
16	28	7	25	40	7	15	32	7	40	55	8	70	100	10	115	140	12
16	30	7	25	42	7	15	35	7	40	60	8	75	95	10	115	150	12
16	32	7	25	47	7	16	28	7	40	62	8	75	100	10	120	150	12
16	35	7	25	52	7	16	30	7	42	55	8	80	100	10	125	150	12
17	28	7	26	37	7	16	32	7	42	60	8	80	110	10	125	160	12
17	28	7	26	42	7	16	35	7	42	62	8	85	110	10	130	160	12

Other sizes available upon request  
若有其他尺寸需求，歡迎與我們聯絡。

# Groove and installation

## 溝槽與安裝

The design of both the housing and shaft play an important role in optimizing the sealing performance of the PTFE Rotary Seals. To avoid damage to the seal during installation process, the mating surface of the shaft and groove should be properly machined. HiPerFlon®, HiPerLip® & HiPerSeal® are installed in open groove and here are some recommendations for the housing and shaft:

為充分發揮鐵氟龍唇式旋轉密封件的優異密封性能與耐用性，並避免安裝不當導致密封件受損，軸的密封面與密封件溝槽必須有適當的加工。HiPerFlon®, HiPerLip® 與 HiPerSeal® 皆安裝於分離式溝槽，而以下為軸與溝槽架構的建議：

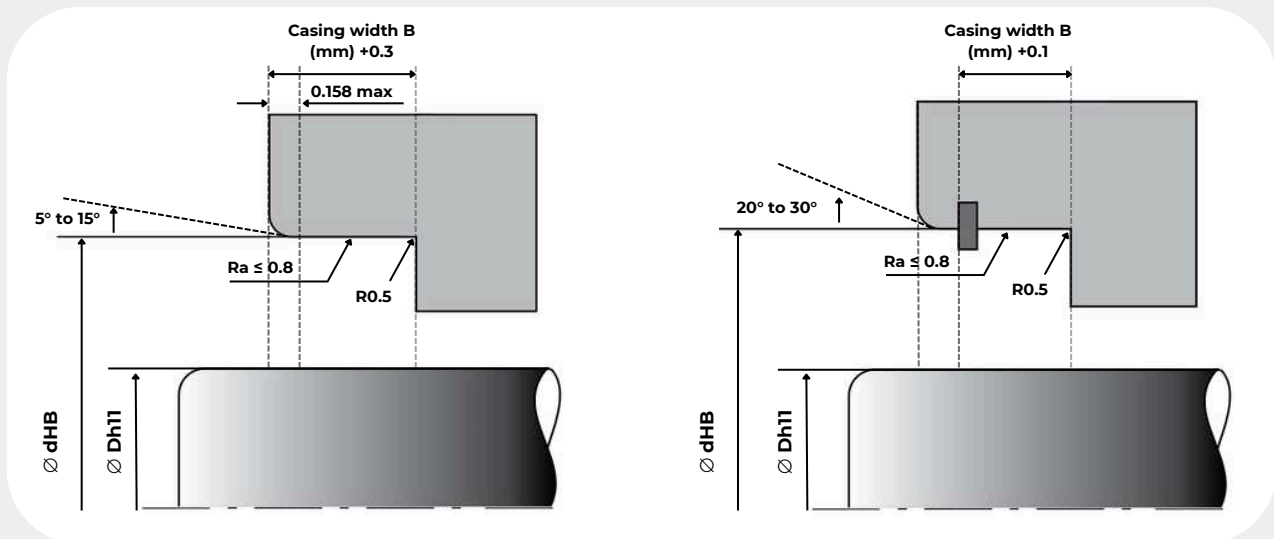

### Shaft Surface

#### Hardness:

- General = > 40 HRC
- Poor lubrication and high speed > 58HRC
- The hardness requirement for a well lubricated environment will generally be lower than poor lubricated conditions, because a lubricating oil film will reduce the friction on the surface.

#### Surface roughness:

- Ra = 0.2~0.5μm for general applications
- Ra < 0.2μm in vacuums
- Tolerance h11, ISO standard 286, Plunge grind surface finish
- Lead-in chamfer 15° to 30° with no sharp edges

### Housing bore

- Surface roughness Ra < 0.8μm for casing bore
- Tolerance H8, ISO standard 286
- Lead-in chamfer 5° to 15°

### 轉軸表面

#### 軸表面硬度:

- 一般 = > 40 HRC
- 潤滑不良或高速運轉的場合 > 58HRC
- 潤滑油膜會減輕表面上的一些摩擦力，減少了對高硬度的需求，所以一般潤滑較好環境的硬度需求就會比潤滑不良的場合還低。

#### 表面粗糙度:

- 一般應用: Ra = 0.2~0.5μm
- 真空應用: Ra < 0.2μm
- 軸徑尺寸公差H11, ISO standard 286
- 端面導角: 15° 至 30°

### 溝槽

- 表面粗度: Ra < 0.8μm
- 軸徑尺寸公差H8, ISO standard 286
- 端面導角: 5° to 15°

When the shaft has the recommended lead-in chamfer of 15° to 30°, the seals can easily install into the shaft without a bullet tool. However, when the hardware is unable to follow the recommended requirements (sharp edges, splines, keyways, or blind installation), the sealing lips can easily be damaged during installation. In this case, an external bullet tool is required. Please refer to the diagrams below. For more information on the bullet tool, please contact Parjet.

當軸有 15° 至 30° 的導入倒角 (如上所建議) 時, 密封件 無需安裝工具即可輕鬆裝入軸中。然而, 當硬件無法遵循建議的要求時, 溝槽周圍鋒利的邊緣很容易在安裝過程中損壞密封件。在這種情況下, 就需要安裝工具輔助, 請參閱下列圖示。有關詳細治具的協助, 請與我們聯繫。

### HiPerLip®

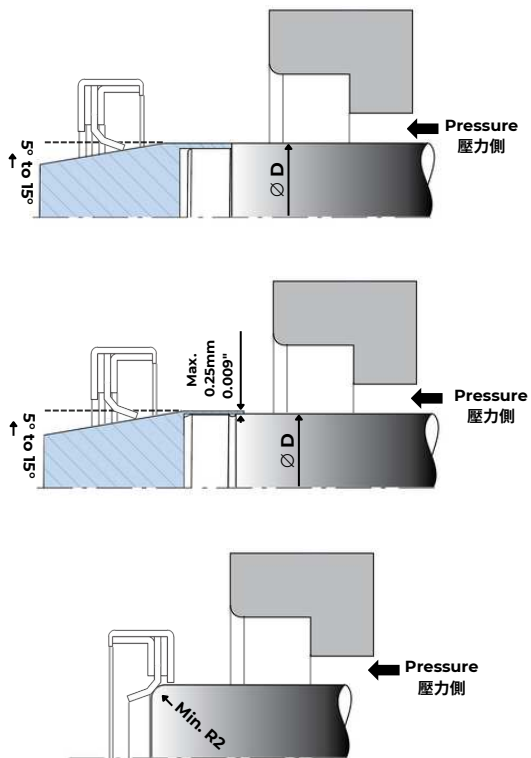

### HiPerFlon®

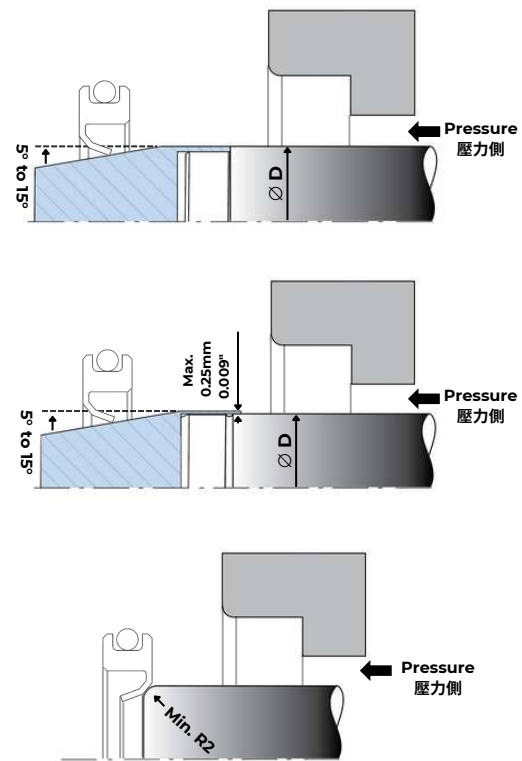

### HiPerSeal®

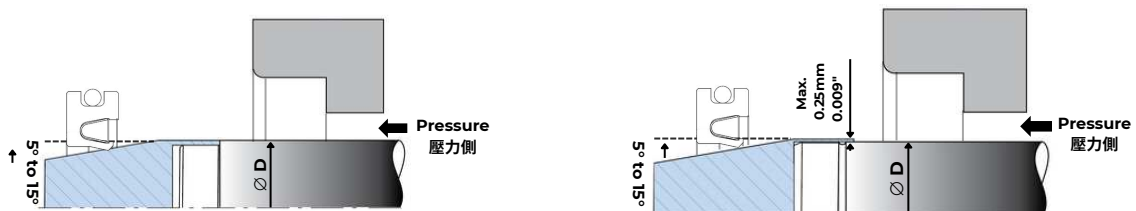

# Inquiry Form

## 詢問表單

### General Information

#### 客戶基本資料

日期 Date			
公司 Company			
聯絡人 Contact Person		電話 Tel	
地址 Address		Email	

### Operating Condition

#### 工作條件

應用 Application	
壓力 Pressure	
壓力方向 Pressure Direction	<input type="checkbox"/> Unidirectional 單向 <input type="checkbox"/> Bidirectional 雙向
轉速 RPM	
溫度 Temperature	
密封介質 Media to Seal	

### Groove Dimension

#### 溝槽尺寸

A: \_\_\_\_\_  
B: \_\_\_\_\_  
C: \_\_\_\_\_

A: \_\_\_\_\_  
B: \_\_\_\_\_  
C: \_\_\_\_\_  
D: \_\_\_\_\_

A: \_\_\_\_\_  
B: \_\_\_\_\_  
C: \_\_\_\_\_  
D: \_\_\_\_\_  
E: \_\_\_\_\_







培凱有限公司

Parjet Co., Ltd.,



 No.36, Heye 2nd Road., Daliao District,  
Kaohsiung City 831130, Taiwan (R.O.C.)  
高雄市大寮區和發產業園區和業二路36號

 [parjet.co@msa.hinet.net](mailto:parjet.co@msa.hinet.net)



[www.parjetseals.com](http://www.parjetseals.com)

 +886 7 788 6950



+886 7 788 0980

Published in June 2024  
出版日期: 06. 2024